User's
Manual

User's Manual

Foreword

Thank you for purchasing our paperless recorder!

This manual is about the functions, settings, wiring methods, methods of operation, failure of treatment methods of the paperless recorder. To ensure correct use, please read this manual carefully and use properly before operation and keep this manual in a safe place for quick reference.

Notice

- The contents of this manual are subject to change without prior notice as a result of continuing upgrades to the instrument's performance and functions.
- Every effort has been made in the preparation of this manual to ensure the accuracy of its contents. However, if you have any questions or find any errors, please feel free to contact us.
- Copying or reproducing all or any part of the contents of this manual without our permission is strictly prohibited.

Revisions

First edition, Dec 2012

Second edition, Mar 2022

Checking the Contents of the Package

Unpack the box and check the contents before operating the instrument. If some of the contents are not correct or missing or if there is physical damage, contact the dealer from which you purchased them.

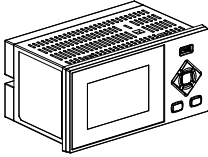

Instrument

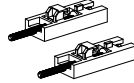

Mounting bracket



User's manual



Software



Certification

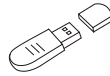

U Disk

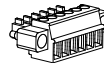

RS485 interface

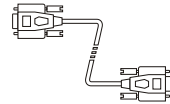

RS232 wire

Appendix

No.	Name	Qty	Notes
1	Instrument	1	
2	Mounting bracket	2	For panel mounting
3	User's manual	1	Order
4	Software	1	Order
5	Certification	1	
6	U Disk	1	Order (max: 32GB)
7	RS485 interface	1	485 interface standard
8	RS232 wire	1	optional Order (length 1.4m)

Note

Because this instrument has many plastic parts, it is necessary to use a dry, soft cloth to wipe the instrument in cleaning. It can not use benzene agents, bananas water and other pharmaceutical in cleaning, or it may cause discoloration or deformation.

Do not put charged products near the signal terminals, which may cause a malfunction.

Please do not impact on the instrument.

If you confirm that the instrument has smoke, odor, noise, etc., please immediately cut off the power supply, and promptly get in touch with the supplier or company.

Content

FOREWORD	1
CHAPTER 1 INTRODUCTION	1
1.1 Instrument structure	2
1.2 Instrument installation	2
1.3 Instrument wiring	4
1.4 Instrument key	6
1.5 Instrument screen and operation	7
1.5.1 Digital display, bar graph and real-time curve screen	8
1.5.2 Function query screen	8
1.5.3 Configuration log and operation	9
1.5.4 Display configuration	10
CHAPTER 2 SYSTEM CONFIGURATION	11
2.1 Factory setting	11
2.2 Clear data	13
CHAPTER 3 ANALOG SIGNAL INPUT	14
3.1 Signal type and specification	14
3.2 Analog input configuration	17
CHAPTER 4 HISTORY DATA FUNCTION	19
4.1 History curve screen	19
4.2 History data backup	20
CHAPTER 5 TRANSMITTER OUTPUT	21
5.1 Transmitter output configuration	21
CHAPTER 6 ALARM FUNCTION	22
6.1 Alarm configuration	22
6.2 Alarm list screen	22
CHAPTER 7 PRINT FUNCTION	23
7.1 Print configuration	23
7.2 Data print screen	24
CHAPTER 8 ACCUMULATIVE REPORT FUNCTION	25
8.1 Accumulative report configuration	25
8.2 Accumulative report screen	26
CHAPTER 9 COMMUNICATION FUNCTION	27
9.1 Register Address	27
9.2 Communication configuration	28
9.3 Modbus-RTU protocol	29
9.4 Modbus/TCP protocol	29
CHAPTER 10 CONFIGURATION BACKUP FUNCTION	31
CHAPTER 11 SYSTEM INFORMATION AND UPGRADE	32

CHAPTER 12 SYSTEM LOG 33
 12.1 System log screen 33
CHAPTER 13 SPECIFICATION 34

Chapter 1 Introduction

The paperless recorder will input signal for all the various needed monitoring records in the industrial site, such as the temperature signal of thermal resistance, and thermocouple, flow signal of the flow meter, pressure signal of the pressure transmitter, etc. Through the data processing of high-performance microprocessor, on the one hand, it can display various forms of screens in high resolution liquid crystal display screen , and on the other hand, it can store the monitoring signal data in large-capacity memory chips inside the instrument in order to query, read and print data and graphics directly.

Feature

- standard instrument size 160mm * 80mm
- monochrome LCD, 320 * 200 resolution
- 4-way universal signal input, mA, V, mV, TC, RTD, etc
- support thermocouple to input cold junction compensation
- high precision signal input $\pm 0.2\%$ F.S.
- it can record 180 days during 1 minute interval , and data will not be lost in 10 years
- channel high- low limit alarm, 4-way relay contact output
- 1-way 4-20mA current output, 1-way 24VDC power distribution
- USB 2.0 interface, support instrument data export
- a variety of data forms, digital, bar graphs, curves
- support channel accumulation, as well as the shift report , daily, monthly and annual report
- standard RS232C/RS485 communication interface, standard ModbusRTU agreement
- it has configuration file backup export functions

1.1 Instrument structure

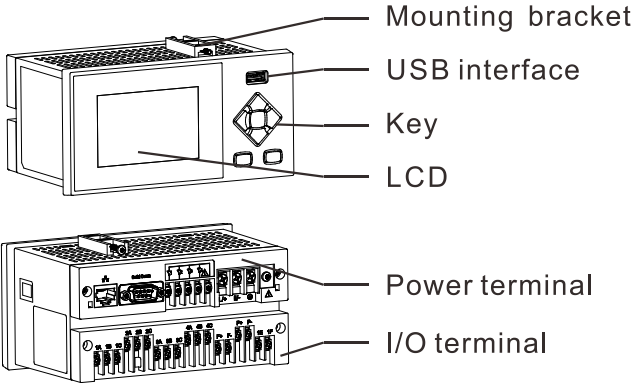

1.2 Instrument installation

It will have a discussion on the installation site and installation methods of this instrument. Be sure to read this section before installation.

Installation Notes:

This instrument is disk mounted type.

Please install indoors to avoid the rain and direct sun.

In order to prevent the increase in the internal temperature of the instrument, please install it in a well-ventilated place.

Do not install the instrument tilt, and try to level the installation (backward $<30^\circ$).

Installation to avoid the following places:

The places near direct sunlight and heat appliances

The places where the ambient temperature exceeds 50°C in working

The places where environment humidity exceeds 85% in working

The places near the electromagnetic generating source

Places with strong mechanical vibrations.

Places with large temperature changes and easy to dew

Places with much fume, steam, moisture, dust and corrosive gas.

Installation method:

Dashboard uses 2 ~ 12mm steel plate.

1. put the instrument in front of the dashboard.

2. Please install with the mounting bracket carried by the instrument, which is shown as below.

Installation graph

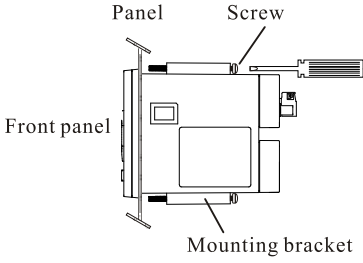

Instrument dimension and Hole size

unit: mm

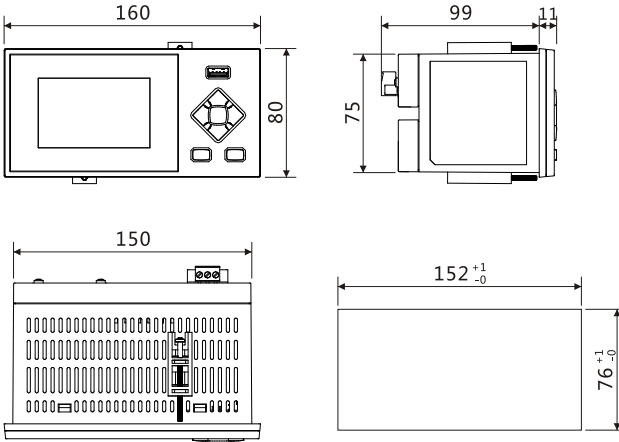

1.3 Instrument wiring

Wiring Method

It is recommended to use a pressure line terminal with insulating sleeve (power terminals M4 screws, signal terminal M3 screws).



Crimp-on lugs (designed for 4 mm screws) with insulation sleeves be used on the lead wire ends.

Please observe the following warning for wiring, or it may cause electric shock or damage to the instrument.

Note

To prevent electric shock, make sure that the instrument is not powered before connecting the signal line.

To prevent fire, use double insulated wire.

Set air switch in the power supply circuit and separate the instrument from the main power.

220VAC supply air switch specification: 1A.

24VDC supply air switch specification: 3A.

Please note to prevent noise from entering the measurement circuit

The measurement circuit should separate from power circuit or ground loops.

Measurement object had better not be a source of interference. Once it can not be avoided, place have the measuring object and measuring circuit insulated, and ground the measuring the sensor.

For the electrostatic induction interference, use shielded cable.

For the Interference produced by electromagnetic induction, wire the measuring loop with equidistant intensive distance.

If the input wiring and other instruments are connected in parallel, it will mutual influence on the measured values.

Signal terminal wiring diagram

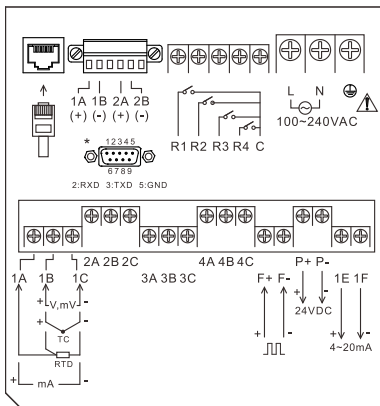

Power terminal	Supply voltage
<p>24V supply</p> <p>24+ 24-</p>	24VDC±10%
<p>220V supply</p> <p>L N ⏚</p>	100VAC-240VAC

Note:

The instrument power supply has 220VAC and 24VDC these two kinds, please note the distinction.

When select [digital] signal for input channel, select the wiring mode of [DC voltage input] for [Voltage], and [RTD signal input] for [Switch].

1.4 Instrument key

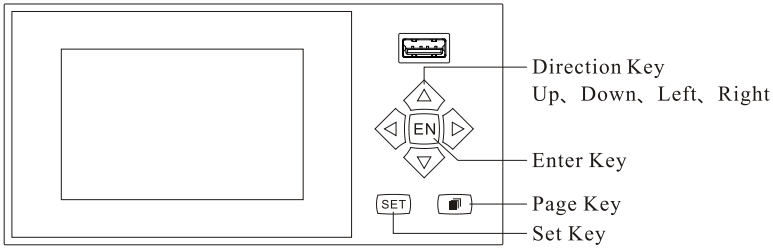

Key Description

Up and down key: switch channel in digital display, bar graphs, real-time curve screen; switch parameters or adjust the value in configuration.

Left and right key: to move the cursor; [left] key can trigger button to print in digital display, bar graphs, real-time curve screen.

Enter key: switch circular display function in digital, bar graphs, real-time curve screen; edit numeric or text, as well as confirm the editing in configuration.

Page key: switch digital, bar graphs, real-time curve function query screen; cancel input values in numeric or text editing.

Set key: press 3 seconds to enter the configuration login in digital display, bar graphs, real-time curve function query screen.

1.5 Instrument screen and operation

The instrument is equipped with a monochrome dot matrix LCD display with a resolution of 320 * 200.

use [page key] to switch the screen in a circular way, and press [set key] for 3 seconds to enter configuration.

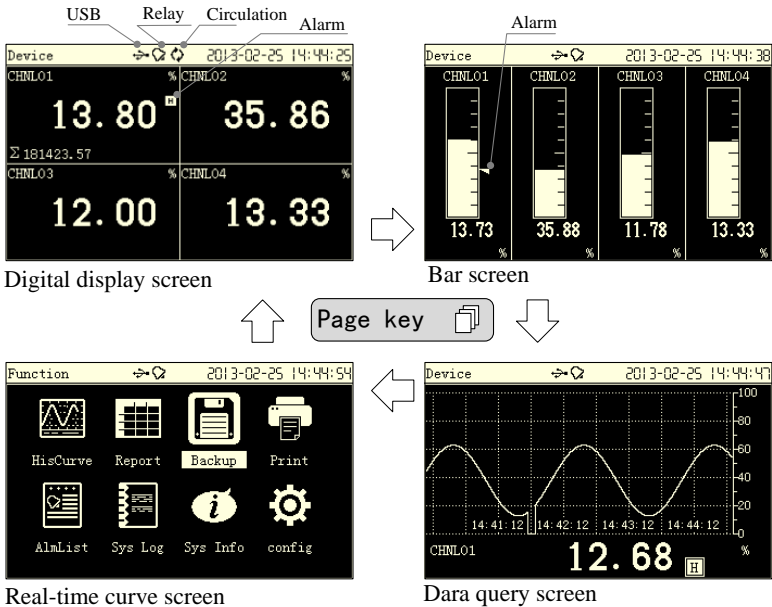

Device name: display the name of the device, and set it in the system configuration.

Relay flag: when the channel alarm has relay connection, display the flag.

USB flag: When the instrument detects the flash drive, display the flag.

Alarm flag: when the channel alarms, H L alarm flag is displayed. The alarm limit is set in the alarm configuration.

Circular display flag: timing circularly displays the data of each channel, and the default is 5 seconds. Press [Enter key] to turn on or off this circular display function. The circular display time parameter is set in the display configuration.

1.5.1 Digital display, bar graph and real-time curve screen

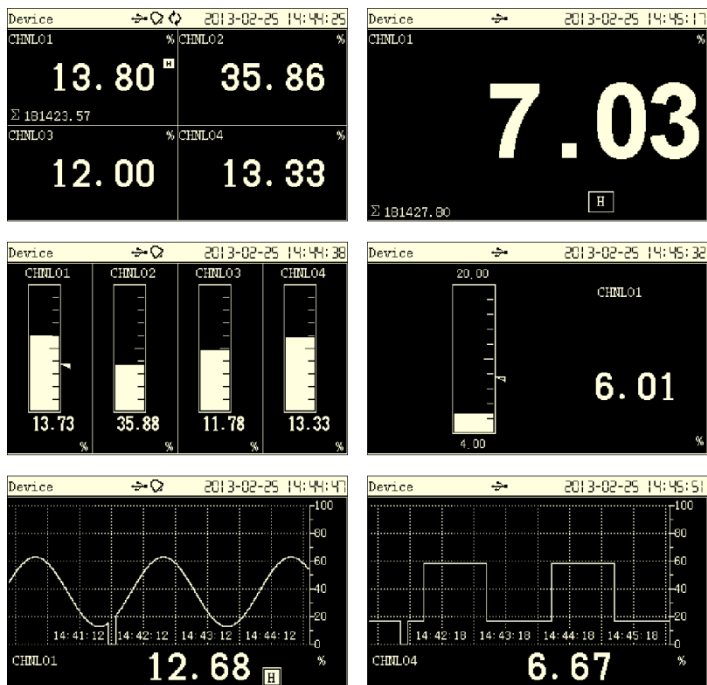

Press [up and down keys] to switch channel display.

Press [Enter key] to open or close the channel circular display.

1.5.2 Function query screen

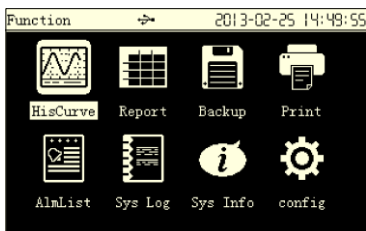

Press [up and down keys, left and right keys] to move the cursor, and press [Enter key] to enter.

Each function screen operation is described in detail in the corresponding functional chapters.

1.5.3 Configuration log and operation

Press [set key] for 3 seconds to enter the configuration login screen, and the initial password is 000000.

Press [Left and right keys] to move the cursor, press [up and down keys] to enter a password, and press [Enter key] to log in.

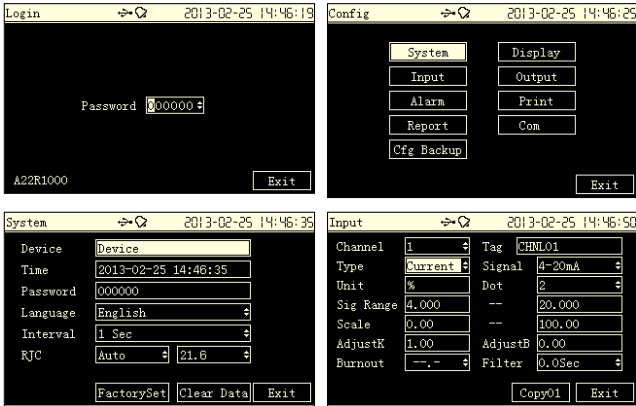

Parameter selection

Press [up and down key] to select the parameter content

Value editing

Press [up and down key] to have value fine-tuning , press [Enter key] , and then pop-up input panel to have input operation.



Press [Left and right keys] to move the cursor, press [up and down keys] to adjust the value, and press [page key] to cancel editing.

Text editing

Press [Enter key], and then pop-up the input panel to have input operation.



Press [left and right key] to move the cursor

Press [Enter] key to select the text, or perform deletion, confirmation, switching soft keyboard and other functions.

When using pinyin, it should press [page] key to skip the cursor to the Chinese selection area, and press the [up and down keys] to elect the Chinese.

1.5.4 Display configuration

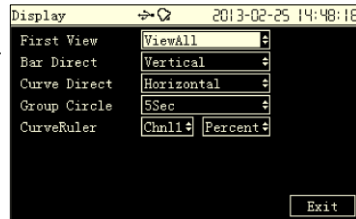
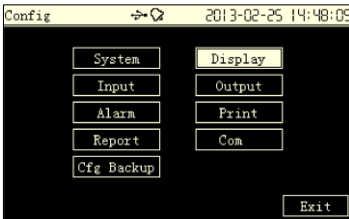

Startup screen: digital display screen, the bar graph screen, real-time curve, function query; the default is digital display screen.

Bar graph direction: vertical, horizontal; the default is vertical.

Curve direction: horizontal, vertical; the default is horizontal.

Combined cycle: the channel circular display interval is 5-60 seconds; the default is 5 seconds.

Curve scale: hundred component, engineering component; each channel independently sets it, and the default is the former.

Chapter 2 System configuration

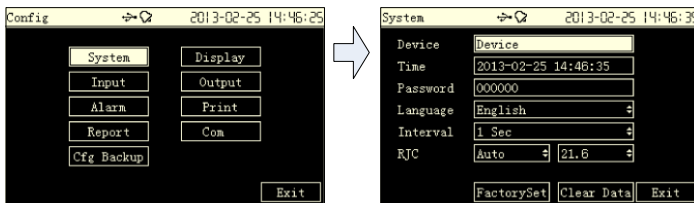

Device name: 15 characters or 7 Chinese characters; display in the digital display, bar graph and real-time curve screen.

System Time: press [Enter key] to edit, and press [page key] to cancel editing.

Configuration password: 000000 to 999999; the default is 000000.

System Language: Simplified Chinese, English; the default is simplified Chinese.

Recording interval: 1 second, 2 seconds, 5 seconds, 10 seconds, 30 seconds, 1 minute, 2 minutes, 5 minutes, 10 minutes, 30 minutes; the default is 2 seconds.

Cold Junction Compensation: automatic, manual; automatically there will be the real-time collection of terminal temperature in automatic condition, and setting value compensation in manual condition; it can fine-tune.

2.1 Factory setting

It will have the implementation of factory settings in the system configuration to restore the instrument parameters to the factory defaults.

System configuration	Device name	“device name ”
	Configuration password	000000
	Recording interval	2S
	RJC	Automatic type, fine-tuning value is 0
display configuration	Start-up screen	Digital display screen
	bar graph direction	vertical
	Curve direction	horizontal
	combination cycle	5S
	curve scale	hundred component
analog input	tag	“channel 01”

analog input	type	current
	signal	4-20mA
	unit	“%”
	decimal point	1
	signal range	4.000~20.000
	range	0.0~100.0
	adjustment K	1.00
	adjustment B	0.0
	burnout settlement	Error flag (-.-)
	filter	0.0S
transmitter output	channel	none
	adjustment K	1.00
	adjustment B	0.00
alarm configuration	channel	Four
	relay delay	4S
	alarm hysteresis	0.00
	alarm1	type: OFF, alarm limit: 0, alarm contact: OFF
	alarm2	type: OFF, alarm limit: 0, alarm contact: OFF
	alarm3	type: OFF, alarm limit: 0, alarm contact: OFF
	alarm4	type: OFF, alarm limit: 0, alarm contact: OFF
print configuration	key print	unavailable
	print blank	unavailable
	print type	All
	timer print	unavailable
	enable endtime	unavailable
	mode	list
	channel	All chn1
	print interval	5 minutes

accumulative report	Daily report settlement	0 o'clock
	shift report number	3
	shift report name	"first shift", "second shift", "third shift"
	Start-end time	0 o'clock ~8 o'clock, 8o'clock~16o'clock, 16o'clock~0 o'clock
	accumulative switch	Close
	decimal point	2
	accumulative initial value	0.00
	accumulative magnification	1.00
Communication configuration	communication address	1
	baud rate	9600
	parity mode	None
	byte order	No exchange

2.2 Clear data

It will implement the function of clearing data in the system configuration to clear the internal storage data, including historical data, accumulative reports, alarm list, and accumulative total.

Chapter 3 Analog signal input

3.1 Signal type and specification

The instrument is 4-channel input, and the instrument measurement period is one second. With small signal resection, inertial filter and other functions, it supports burnout judgment, and the signal type is as follows.

Input method	Input type	Measurement range
current	4~20mA	4.00 ~ 20.00mA
	20mA	0.00 ~ 20.00mA
voltage	1-5V	1.000 ~ 5.000V
	5V	-5.000 ~ 5.000V
	10V	-10.00 ~ 10.00V
	20mV	0.000mV ~ 20.000mV
	100mV	0.00mV ~ 100.00mV
resistance	400Ω	0.0 ~ 400.0Ω
Thermal resistance	Pt100	-200.0 ~ 650.0°C
	Cu50	-50.0 ~ 150.0°C
	BA1	-200.0 ~ 650.0°C
	BA2	-200.0 ~ 650.0°C
thermocouple	S	-50.0 ~ 1768.0°C
	R	-50.0 ~ 1768.0°C
	B	0 ~ 1820°C
	K	-200.0 ~ 1372.0°C
	N	-200.0 ~ 1300.0°C
	E	-200.0 ~ 1000.0°C
	J	-210.0 ~ 1200.0°C
	T	-200.0 ~ 385.0°C
	WRE5-26	0 ~ 2310°C
	WRE3-25	0 ~ 2310°C
	F1	700 ~ 2000°C
	F2	700 ~ 2000°C
Original vacuum Segmented vacuum	4~20mA	4.00 ~ 20.00mA
	1-5V	1.000 ~ 5.000V
	5V	-5.000 ~ 5.000V
	10V	-10.00 ~ 10.00V
Square root	4~20mA	4.00 ~ 20.00mA

Square root	20mA	0.00 ~ 20.00mA
	1-5V	1.000 ~ 5.000V
	5V	-5.000 ~ 5.000V
	10V	-10.00 ~ 10.00V
frequency	Fr	0~10000Hz
Analog	Sin	4.00 ~ 20.00
	Cos	4.00 ~ 20.00
	Square	4.00 ~ 20.00
	Triangle	4.00 ~ 20.00
Digital	Voltage	0 (0V ~ 0.8V) , 1 (2V ~ 5V)
	Switch	0 (200Ω~ ∞) , 1 (0 ~ 80Ω)

Frequency signal uses a dedicated channel, 1 channel.

Note

Signal input should not exceed the following values; otherwise it will damage the instrument.

Voltage mV signal and thermocouple -1V ~ +5V

Voltage V signal -12V ~ +12V

Current signal -4mA ~ +25mA

The largest common mode interference 250VACrms (50Hz)
voltage

Ordinary vacuum operation

Semaphores and vacuum degree of logarithm has a linear relationship, signal range in the overall signal is free to set, and the project range is expressed by 10 of the index form, ranging from $10E-9.999$ to $10E9.999$.

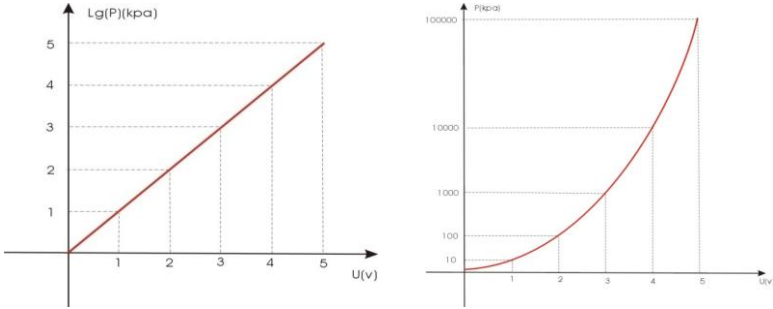

Sub-vacuum operation

According to the vacuum degree of order, divide it into a number of sections, the corresponding signal of endpoint in every section and the vacuum degree has a linear relationship, at the same time, corresponding signal in the same section and the vacuum have a linear relationship too. Signal range in the overall signal is free to set; the project range is expressed by 10 of the index form, ranging from $10E-9.999$ to $10E9.999$.

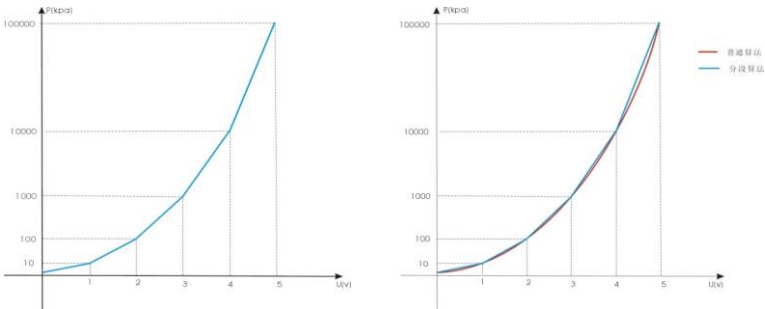

Digital operation

Voltage: Access voltage signal: $0 \sim 1V$, displayed as 0; When $\geq 1V$, displayed as 1.

Switch: Access RTD signal: $0 \sim 100 \Omega$, displayed as 0; When $\geq 100 \Omega$, displayed as 1.

3.2 Analog input configuration

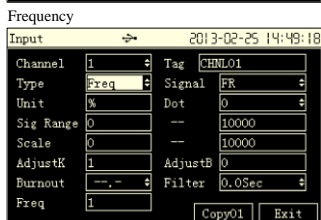
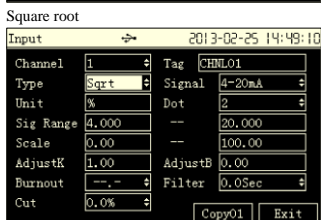
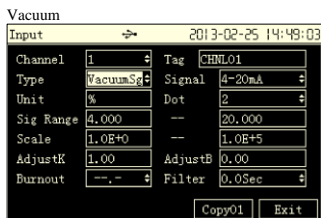
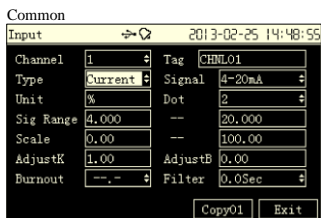
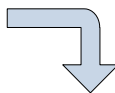

Channel: 1-4 is optional.

Tag: 15 characters or 7 Chinese characters.

Type: refer to section 3.1.

Signal: refer to section 3.1.

Unit:%, A, mA, V, mV, Ω , $^{\circ}\text{C}$, $^{\circ}\text{F}$, t/h, kg/h, m³/h Nm³/h, Pa., mbar.

The unit can be freely edited, 7 characters or 3 Chinese characters.

Decimal point: channel project amount displays decimal point, 0-3 can be grouped.

Signal range: it can be freely set within signal range, refer to section 2.1.

Range: range from -9999 to 30000,0-3 decimal places; in vacuum type, it is the index.

Adjustment KB: the project amount after adjustment = K * project amount + B.

Burnout processing: the channel data processing method when the signal is disconnected; maximum, minimum, maintain, --- is optional.

Filtering: 0.0 second to 9.9 seconds can be grouped.

Resection: square root type is effective, 0.0% to 9.9%.

Frequency coefficient: frequency type is effective, the project amount = $f /$
frequency coefficient, 0-30000, 0-3 decimal places.

Chapter 4 History data function

This instrument saves the measurement data in real time, and writes to the internal memory.

Historical data: 4-channel project amount.

Recording interval: 1 second, 2 seconds, 5 seconds, 10 seconds, 30 seconds, 1 minute, 2 minutes, 5 minutes, 10 minutes, 30 minutes.

The recording interval is set in the system configuration.

Record time: 1 second recording interval, which can be recorded continuously for three days; 1 minute recording interval, which can be recorded continuously for 180 days.

Note

Increasing the length of recording interval can extend the time of storing data in the instrument.

Modifying the recording interval can cause the failure of historical data stored in the internal instrument, and therefore, it is necessary to back up history data to prevent loss before modifying the recording interval.

4.1 History curve screen

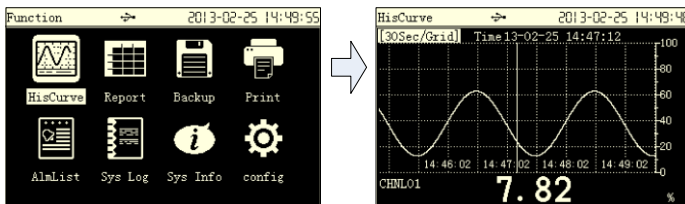

Press [Up and down keys] to switch the channel, press [left and right keys] to move the cursor

Press [Enter key] to modify the grid precision, and set searching time.

4.2 History data backup

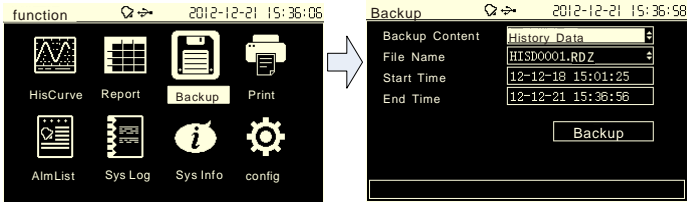

- Turn the page to the Function screen, press [left and right keys] to select the data backup, Press [Enter key] to enter the Backup screen.
- Press [Up and down keys] to select the data backup content: History Data, Shift Report, Day Report, Mouth Report, Year Report, Alarm List and System Log.
- Press [Up and down keys] or [Enter key] to change the file name. It can be composed of numbers, majuscules, lowercases and symbols. The name length is 8 characters. The history data backup file name format is ". RDZ".
- **Start time, end time:** the starting and ending time of the history data backup.
- USB connection flag will appear at the top of the display after inserting the U Disk. Select Backup and press [Enter key] can backup history data to the U Disk. If the backup fails will show "Failed to write file", if it success will show "Backup data finished", then you can unplug the U Disk.

Chapter 5 Transmitter output

This instrument provides a 1-channel 4-20mA analog transmitter output function, and the load is less than 750Ω.

5.1 Transmitter output configuration

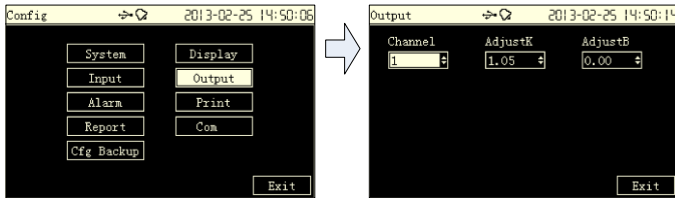

Channel: 4 channels can be grouped.

Adjust K B: Output current = $K * \text{Output Current} + B$.

Chapter 6 Alarm function

This instrument has a channel high and low alarm function, and there is 4 alarm limit value, and supports 4-channel relay output.

It saves 256 alarms, including alarms or elimination time of report, alarm type, alarm channel and alarm status.

6.1 Alarm configuration

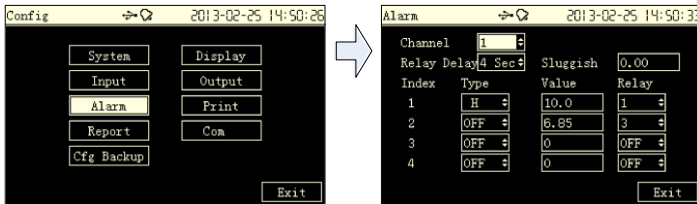

Channel: 4 channels (optional)

The relay delay: 0-10 seconds; the default is 4 seconds.

Alarm hysteresis: 0 to 30000, decimal point 0-3; the default is 0.

Alarm type and alarm limits:

Alarm type	Alarm condition	Elimination report condition
H alarm	Channel value > high limit	Channel value < high limit - hysteresis
L alarm	Channel value < low limit	Channel value > low limit + hysteresis

Optional relay: 1-4 channel

6.2 Alarm list screen

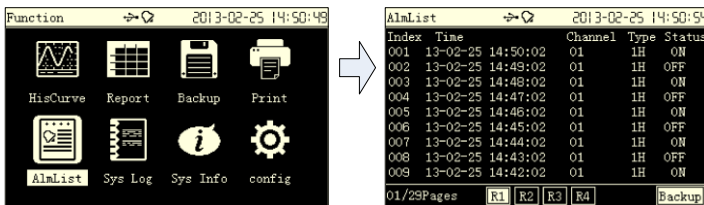

Press [Up and down keys] to scroll the alarm list information, and perform backup functions to directly enter the backup screen.

Chapter 7 Print function

The instrument is equipped with an external micro printer.

Timing print: automatically timing print data, including channel project amount and the accumulated amount; print interval parameter can be set.

Print button: [left] key trigger print in digital display, bar graph, curve screen. Print channel project amount and the accumulated amount.

Data printing: a dedicated print screen to print historical data or historical curve.

Print blank: An additional blank will be printed to ensure that the paper at the printer outlet contains all printed data..

7.1 Print configuration

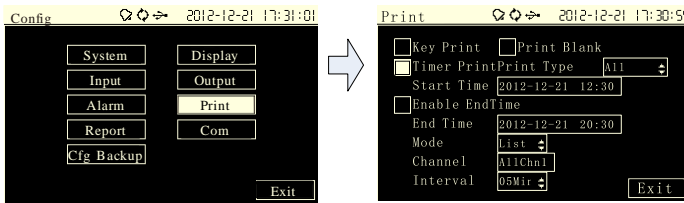

Print type: All, Value and Accu.

Start Time, End Time: the timing print start time and end time.

Mode: press [Up and down keys] to choose List or Curve. The list corresponds to the all channel, and the curve can select channels from 1 to 4.

Print interval: 1 minute, 2 minutes, 5 minutes, 10 minutes, 30 minutes, 1 hour, 2 hours, 4 hours, 8 hours, 12 hours, 24 hours.

7.2 Data print screen

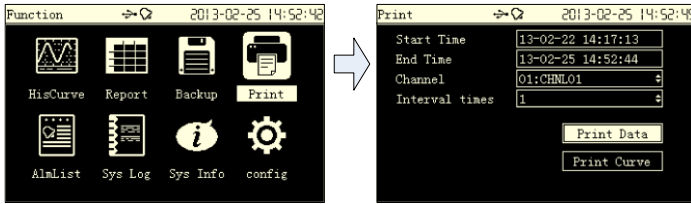

Start time, end time: the starting and end time of printing the historical data.

Print channel: 4 channels are optional.

Interval multiples: If the recording interval is 1 second, the multiple is 60.

Printing takes the number of 1 minute interval.

Print data, print curve: press [Enter key] to execute print function.

Chapter 8 Accumulative report function

The instrument has four kinds of reports, including channel shift report, daily, monthly and annual reports.

8.1 Accumulative report configuration

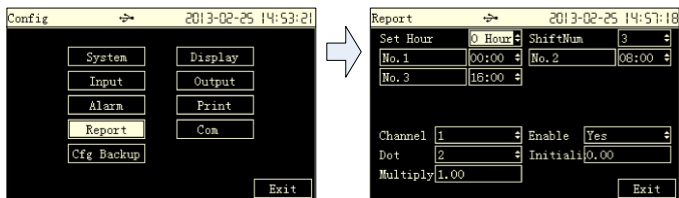

Daily report settlement: the day settlement point of daily, monthly, annual report, 0-23 o'clock can be grouped.

The number of shift report: 2-5 class can be grouped.

Shift name: press [Enter key] to modify shift name, such as early morning shift, evening shift.

Shift time: 0-23 can be grouped.

Channel: 1-4 channels are optional.

Cumulative switch: set independently for each channel.

The decimal point: the total amount of the decimal point, 0-3 can be grouped.

The total setting: set the cumulative total, and the instrument saves the setting value.

Cumulative magnification: instantaneous cumulative amount times the magnification and then accumulate it.

8.2 Accumulative report screen

Function → 2013-02-25 14:53:44

HisCurve Report Backup Print

AlnList Sys Log Sys Info config

Report → 2013-02-25 14:58:12

Shift Report Chn101 2012-01-01 Backup

No. 1 0.18

No. 2 0.00

No. 3 0.39

Sun 0.58

Σ 0.58

Report → 2013-02-25 14:54:01

Day Report	Chn101	2013-02-25	Backup
01:00	12:00	23:00	
02:00	13:00	00:00	
03:00	14:00		
04:00	15:196.69		
05:00	16:00		
06:00	17:00		
07:00	18:00		
08:00	19:00		
09:00	20:00		
10:00	21:00		
11:00	22:00	Sun 196.89	
			Σ 181464.39

Report → 2013-02-25 14:54:09

Month Report	Chn101	2013-02	Backup
01:6180.00	12:00	23:00	
02:6180.01	13:00	24:00	
03:6180.00	14:00	25:197.31	
04:6179.80	15:3821.91	26:00	
05:4555.11	16:6179.97	27:00	
06:00	17:6180.00	28:00	
07:00	18:2173.75		
08:00	19:3161.52		
09:00	20:2811.35		
10:00	21:108.06		
11:00	22:00	Sun 54013.88	
			Σ 181465.00

Report → 2013-02-25 14:54:17

Year Report Chn101 2013 Backup

2013-01:127825.27 2013-12:0.00

2013-02:54014.59

2013-03:0.00

2013-04:0.00

2013-05:0.00

2013-06:0.00

2013-07:0.00

2013-08:0.00

2013-09:0.00

2013-10:0.00

2013-11:0.00

Sun 181839.86

Σ 181465.72

Switch report type

Switch channel

Report time

Report backup

It can switch the type of report (shift report, daily, monthly and annual report), channel, time, display the corresponding report data.

Using the backup function can directly enter report backup screen.

Chapter 9 Communication function

This instrument provides standard RS232C/RS485 serial communication interface and RJ45 Ethernet Interface, adopts a common international standard Modbus-RTU and Modbus/TCP communication protocol, and supports 04 Read Holding Registers command.

9.1 Register Address

Communications data and register address is as following:

parameter	type	address	description
Channel1 Real time value	short	30001	Short integer fixed-point number. e.g. 12.00 is 1200.
Channel2 Real time value	short	30002	
Channel3 Real time value	short	30003	
Channel4 Real time value	short	30004	
Channel1 Real time value	float	30005	4-byte floating-point number. Byte order can be configured, and the default is no exchange.
Channel2 Real time value	float	30007	
Channel3 Real time value	float	30009	
Channel4 Real time value	float	30011	
Channel1 Accumulation	ulong	30013	4-byte integer Byte order can be configured, and the default is no exchange.
Channel2 Accumulation	ulong	30015	
Channel3 Accumulation	ulong	30017	
Channel4 Accumulation	ulong	30019	

9.2 Communication configuration

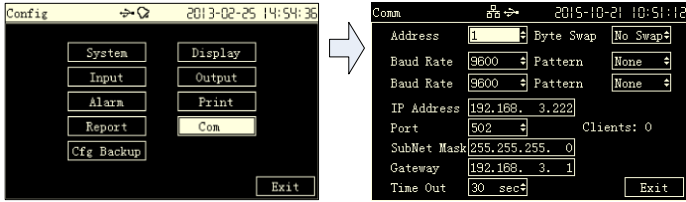

Address: 1-247.

Byte Swap: no exchange or exchange (additional: the default is no exchange);

Arrange order for the 32-bit data (long integer or floating-point) in the communication frame.

e.g.: long integer 01020304H:

No exchange: 03 04 01 02 Exchange: 01 02 03 04

Floating-point number 4.00 (40800000H):

No exchange: 00 00 40 80 Exchange: 40 80 00 00

Baud Rate: 1200, 2400, 4800, 9600, 19200, 38400, 57600; the default is 9600.

Parity: no parity, odd parity, even parity; the default is no parity.

IP Address: It is the only address of each different internet devices, which is used for distinguishing devices.

Port: Software port number for Ethernet connects. The default value is 502.

Mask: It is set according to different IP address. Default mask: 255.255.255.0.

Gateway: The address of gateway.

Timeout: The connections retry intervals.

9.3 Modbus-RTU protocol

Modbus based on serial communication run on the RS-232 or RS-485 bus, and in RTU mode, each byte format is:

- 1 Start bit
- 8 data bit, the lowest valid bit is sent first
- 1 parity bit, no parity is none
- 1 Stop bit

In Modbus based on serial communication, the additional address domain uses a 1-byte slave station address, and the data verification domain uses a 2-byte CRC check, the frame format is as follows:

Slave station address (1byte)	Function code (1byte)	Data (0~252byte)	CRC check (2byte)
----------------------------------	--------------------------	---------------------	----------------------

For example:

Ask: 01 04 00 00 00 01 31 CA

Slave station address	Function code	Data		CRC check (LSB)
		Register address	The number of registers	
01	04	00 00	00 01	31 CA

Response: 01 04 02 00 64 B8 DB

Slave station address	Function code	Data		CRC check (LSB)
		The number of bytes	Register data	
01	04	02	00 64	B8 DB

9.4 Modbus/TCP protocol

Modbus TCP runs on the TCP/IP network and all Modbus TCP frames are emitted via TCP register port 502.

When Modbus is applied to TCP/IP, the additional address domain uses a dedicated message header to identify the Modbus application data unit, which is called the MBAP message header(Modbus protocol message header). In addition, there is no data verification domain on TCP/IP, the accuracy of the transmitted

data is verified by the TCP/IP and link layer (Ethernet) verification mechanism, the frame format is as follows:

MBAP prefix (7byte)	Function code (1byte)	Data (0~252byte)
------------------------	--------------------------	---------------------

The MBAP prefix (Modbus Application Protocol header) format is as follows:

Domain	Length	Description
The thing meta-identifier	2 byte	An identifier for request/response transaction processing, which is used for transaction pairing. The configuration is initialized by the requester, then responder copies the transaction identifier of the request.
Protocol identifier	2 byte	0 identified as the Modbus protocol.
Length	2 byte	Subsequent data bytes, including cell identifiers, function codes, and data.
Cell identifier	1 byte	The identification number of a remote slave station connected on a serial link or other bus is generally the slave station address of a meter.

For example:

Request: 00 00 00 00 06 01 04 00 00 00 01

MBAP prefix				Function code	Data	
					Register address	The number of registers
00 00	00 00	00 06	01	04	00 00	00 01

Response: 00 00 00 00 05 01 02 00 64

MBAP prefix				Function code	Data	
					The number of bytes	Register data
00 00	00 00	00 05	01	04	02	00 64

Chapter 10 Configuration backup function

The instrument supports the backup of the configuration and import function.

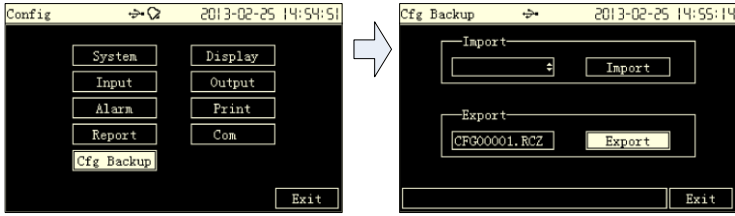

Press [up and down keys] or [Enter key] in exporting configuration file name to change the file name, and the export file is stored in the CONFIG directory of USB.

Instrument automatically recognizes the configuration file under the CONFIG directory of USB, and imports the configuration through the import function.

Chapter 11 System information and upgrade

The instrument supports the program upgrade through U disk.

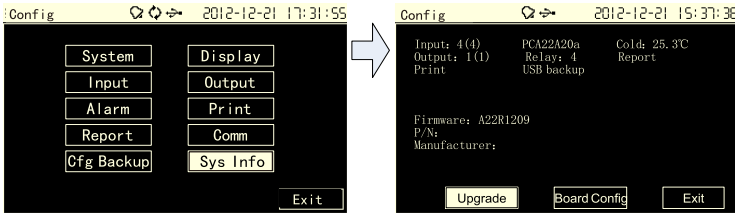

Put the program file (such as A22R. img) provided by the manufacturer into the U disk, and insert the U disk into the USB socket of the instrument to be upgraded.

Enter system information screen and choose Upgrade.

The letter “firmware file has been found!” is displayed below, and a prompt window will pop up. After checking and confirming that the original firm and the upgraded firm are correct, select Yes.

Wait until the firmware upgrade is completed, restart the instrument, return to the system information interface, confirm that the firmware version has been updated, and unplug the U disk.

Chapter 12 System log

This instrument has a log recording feature, and saves the latest 512 system operation logs, including the content and time of operation.

Record the following types of operations: configuration modification, power-down record, factory settings and clearing data, configuration import, serial write configuration, the total setting.

12.1 System log screen

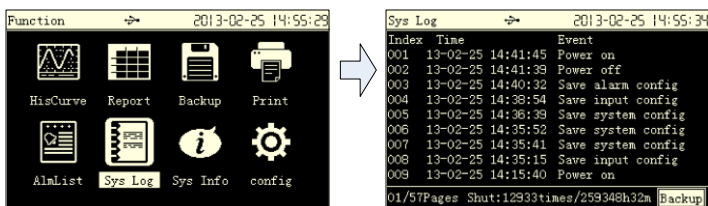

Press [up and down, left and right keys] to read the system log

Chapter 13 Specification

Item	Specification
AC power supply	100VAC ~ 240VAC, 50Hz, Open specification 1A
DC power supply	24VDC±10%, open specification 3A
Overall Power Consumption	≤10W
Channel signal	1-4 channel Current 4~20mA 20mA Voltage 1-5V 5V 10V 20mV 100mV resistance 400Ω thermal resistance Pt100 Cu50 BA1 BA2 thermocouple S R B K N E J T WRE5-26 WRE3-25 F1 F2 Frequency Fr Digital Voltage Switch
measurement precision	≤ 0.2%F.S.
Frequency signal	Low level 0-2V High level 4-24V
Input impedance	Current signal 250Ω
Resistance measurements incentives	Current 0.25mA
Burnout detection current	About 1uA
The largest common mode noise voltage	250VACrms(50Hz)
Recording capacity	4MB built-in 72 hours (4-channel, 1 second recording interval) 180 days (4-channel, 1 minute recording interval)
Recording mode	Circular recording
Data storage	Storage life limit is more than 10 years

alarm type	High and low limit alarms, 4 for per channel 4
relay	4-channel normally open relay, 250VAC/3A, 30VDC/3A (resistive load)
number of alarm records	256
analog output	1 channel 4-20mA output, load is less than 750Ω
power distribution	1 channel 24VDC power distribution, the maximum output current is 60mA
communication	RS232C(1 Port) or RS485(2 Port) Ethernet(10M-base) Standard Modbus-RTU/Modbus-TCP protocol
Clock	2000 year ~ 2099 year
Clock Accuracy	±10ppm(25°C)
Battery Life	About 10 years(room temperature)
Operating temperature	0°C ~ 50°C
Operating humidity	0% ~ 85%(no condensation)
Installation location	indoors
Storage ambient temperature	-10°C ~ 60°C
Storage ambient humidity	0% ~ 95%(no condensation)
Installation	Platter
Mounting angle	Inclined backwards on the horizontal level < 30 degrees
Mounting plate thickness	1 ~ 12mm
Instrument Material	ABS plastic
External dimensions	160 (W) × 80 (H) × 100 (D)
Weight	About 0.5Kg
Display	Monochrome LCD, 320 * 200 resolution
key	7 button design, the up, down, left, and right, enter , page , setting

USB port	Compatible with USB2.0 protocol
Number of ports	1
Capacity	Max: 32GB
Power Supply	5V±10%, 100mA
Devices can be connected	U disk
