

# User Manual

---

## Preface

Thank you for purchasing our products!

This manual is about meter functions, settings, connection methods, operation flow, and methods to identify the faults. Please read this manual carefully before operating and using it correctly.

After reading it, please keep it properly in the place where you may read it any time for your reference.

## Note

Modification of this manual contents will not be notified as a result of some factors, such as function upgrading.

We try our best to guarantee that the manual content is accurate, if you find something wrong or incorrect, please contact us.

Any reprint and copy of the manual content are strictly prohibited either in whole or in part.

## Version

IMQ53H-EZ02c    the second edition    May. 2022

CHAPTER 1 SAFETY INSTRUCTIONS .....	- 1 -
1.1 Manufacturer's Safety Instructions .....	- 1 -
1.2 Safety Instructions for Operators .....	- 3 -
CHAPTER 2 EQUIPMENT INTRODUCTION .....	- 4 -
2.1 Scope of Delivery .....	- 4 -
2.2 Principle of electromagnetic flowmeter measurement .....	- 5 -
2.3 Heat meter operating principle .....	- 6 -
2.4 Structure of electromagnetic flowmeter .....	- 7 -
2.5 Use environment description .....	- 8 -
2.6 Terminal description .....	- 9 -
2.7 Name Plate .....	- 10 -
CHAPTER 3 INSTALLATION .....	- 11 -
3.1 Installation Tips .....	- 11 -
3.2 Storage .....	- 11 -
3.3 Installation Requirements .....	- 11 -
3.4 Piping design .....	- 12 -
3.5 Sensor installation process .....	- 14 -
3.6 Heat meter installation requirements .....	- 17 -
3.7 Machinery installation .....	- 19 -
3.8 Dimensions of the pipeline electromagnetic flowmeter .....	- 20 -
CHAPTER 4 ELECTRICAL CONNECTION .....	- 22 -
4.1 Safety Tips .....	- 22 -
4.2 Connect Signal and Magnetic Field Current Cable .....	- 23 -
4.3 Measurement Sensor Ground .....	- 25 -
4.4 Connected to Power .....	- 26 -
4.5 Input introduction .....	- 28 -
4.6 Output introduction .....	- 29 -
CHAPTER 5 STARTUP .....	- 31 -
5.1 Power on .....	- 31 -
5.2 Converter startup .....	- 31 -
CHAPTER 6 OPERATION .....	- 32 -
6.1 Heat display and operation Button .....	- 32 -
6.2 Flow display and operation Button .....	- 33 -
6.3 Operating instructions for mechanical keys .....	- 35 -
6.4 Operating instruction .....	- 36 -
6.5 Configuration details .....	- 41 -
6.6 Quick setup menu .....	- 54 -
CHAPTER 7 FUNCTIONS .....	- 55 -
7.1 System information .....	- 55 -
7.2 Accumulated report instructions .....	- 56 -
7.3 Pulse/Frequency/Current output .....	- 60 -
7.4 Serial communication .....	- 62 -

7.5	Hart Communication	- 64 -
7.6	Bluetooth communication	- 71 -
7.7	Firmware upgrade instructions	- 73 -
7.8	Operation instructions of flow correction function	- 74 -
CHAPTER 8 TECHNICAL PARAMETERS		- 78 -
8.1	Technical parameters	- 78 -
8.2	Flow Meter	- 81 -

## Chapter 1 Safety Instructions

### 1.1 Manufacturer's Safety Instructions

#### **Copyright and Data Protection**

The content of this document has been checked carefully, but we do not guarantee that the contents are totally accurate, and it is in accordance with the latest version.

The contents and works of this document are under China's copyright protection. Materials from the third party have been marked. Any copy, processing and transmission of it out of the scope of copyright, in any forms, must get the written permission of the authors or the manufacturer.

Manufacturers always try to respect the copyrights of others and try to use their own works or works without authorization.

Personal data (such as name, address or E-mail address) used in manufacturer's documents, if possible, are conducted on a voluntary basis. Use of products and services, if possible, starts without having to provide personnel data. We remind you: data transmission on the Internet (such as communicating via email) may possibly meet security vulnerabilities. We can't give security guarantee that data will definitely not be obtained by a third party. Here, we are clearly against the third-party using contact data, within the scope of copyright notice obligation, to send advertising materials without any requirement.

#### **Exemption Clause**

The manufacturer will not bear the responsibility for any forms of loss caused by using the product; these consequences include direct, indirect or accidental losses as well as these coming from punishment, but not limited to these consequences.

If the manufacturer has intentional behavior or gross negligence, the disclaimer is invalid. If it is not allowed to limit the product's self-assurance, nor is it allowed to waive or limit certain types of compensation, and these rights are suited for you as well as according to applicable laws, in this case the above disclaimer or limitations may partially or completely not apply to you.

For every purchase of products, they are applicable to product documentation and manufacturer's sale terms.

## Safety Instructions

---

As for document contents including this disclaimer, the manufacturer reserves and has the right to modify at any time in any way for any reason without any notice in advance, and it will not bear the responsibility for the consequences coming out of any forms of change.

### **Product Liability and Warranty**

The operator judges whether the flow meter serves the purpose and bear the responsibility for it. The manufacturer does not assume the consequences caused by operator's misuse of meter. Wrong installation and operation of flow meter (system) will lead to deprive of warranty rights. In addition, the corresponding 'standard sales terms' applies as well, and the clause is the basis of purchase contract.

### **Document Details**

In order to avoid harm or damage to the equipment when used improperly, please make sure reading the information in this document before using it. In addition, you must comply with national standards, safety regulations and accident prevention rules.

If you can't understand this document, please ask the manufacturer for help. The manufacturer will not take the responsibility for property loss or physical injuries due to misunderstanding of the information contained in the document.

This document will help you to establish favorable operating conditions so as to make sure that you use the equipment in a safe and effective way. In addition, something of particular attention and safety measures in the document are marked by the following marks.

### **Display Convention**

The following symbols will make it easier for you to use this document.



### **Danger!**

This symbol signifies related and important safety tips.



### **Warning!**

Such warnings must be paid attention to. Slight negligence may lead to serious health threat, and may damage the equipment itself or the operating factory facilities.



### **Note!**

Such warnings must be paid attention to. Any slight negligence may also lead to functional fault of the equipment itself.



### **Tips!**

This symbol signifies related important information concerning operating instrument.

## 1.2 Safety Instructions for Operators



### **Warning!**

Only corresponding personnel who got trained and authorized is allowed to install, use, operate and maintain the equipment. This document will help you to establish favorable operating conditions so as to make sure that you use the equipment in a safe and effective way.

## Chapter 2 Equipment Introduction

### 2.1 Scope of Delivery

**Tips!**

Please check whether the boxes are damaged or not, and whether they have been handled roughly or not. Please report the damage to the deliverer and the manufacturer.

**Note!**

Please check the packing list to make sure that all the goods you received are integrated.

**Note!**

Please check the name plate of the equipment, and confirm whether the power supply is the same as your order. If incorrect, please contact manufacturer or supplier.



## 2.2 Principle of electromagnetic flowmeter measurement

### Principle of electromagnetic flowmeter measurement

The working principle of electromagnetic flowmeter is based on Faraday's electromagnetic induction law. In the figure, the two electromagnetic coils at the top and bottom generate constant or alternating magnetic fields. When the conduction medium flows through the electromagnetic flux, the induction electromotive force can be detected between the left and right electrodes on the wall of the flowmeter. The magnitude of this induction electromotive force is proportional to the velocity of the conducting medium, the magnetic induction intensity of the magnetic field and the conductor width (the inner diameter of the flowmeter measuring tube). The equation of induced electromotive force is:

$$E=K \times B \times V \times D$$

Among them:

- E - induced electromotive force
- K - instrument factor
- B - Magnetic induction intensity
- V - average flow rate in the pipe section
- D - the inner diameter of the pipe

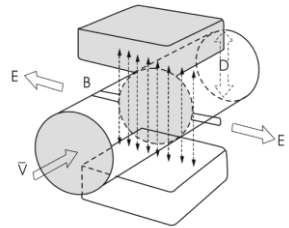

Measuring flow rate, fluid flows through the magnetic field perpendicular to the flow direction, fluid flow induction conductivity an induction electric potential is proportional to the average flow velocity, so the measured conductivity is higher than the minimum of the electric conductivity of liquid flow - 5 us/cm (electromagnetic flowmeter can measure conductivity greater than 5 us/cm theoretically conductive medium, but should guarantee the electromagnetic flowmeter in practical measurement used in the electrical conductivity measured medium in 30 us/cm or above (greater than the theoretical value for one to two orders of magnitude) environment, and must be based on online measurement of electrical conductivity value). The induced voltage signal through two electrodes detection, and through the cable sent to converter, after a series of analog and digital signal processing, cumulative flow and transient flow display screen in converter.

# Equipment Introduction

## 2.3 Heat meter operating principle

Heat meter operating principle: Hot (cold) water supplied by a heat source flows into a heat exchange system at a high (low) temperature (a radiator, heat exchanger, or complex system consisting of them), Outflow at low (high) temperature, in which heat is released or absorbed to the user through heat exchange (note: this process includes energy exchange between heating system and cooling system). When water flow through the heat exchange system, according to the flow sensor of flow and matching the temperature of the sensor is given for the return water temperature, and flow through time, through the calculation of the calculator and display the system heat release or absorption.

$$Q = \int_{\tau_0}^{\tau_1} q_m \times \Delta h \times d\tau = \int_{\tau_0}^{\tau_1} \rho \times q_v \times \Delta h \times d\tau$$

Q : Heat released or absorbed by the system, JorkWh;

$q_m$ : Mass flow of water through a heat meter, kg/h;

$q_v$ : Volume flow of water through the heat meter, m<sup>3</sup>/h;

$\rho$ : The density of water flowing through the heat meter, kg/ m<sup>3</sup>;

$\Delta h$ : The difference in enthalpy between inlet and outlet temperatures of the heat exchange system, J/kg;

$\tau$ : time, h.

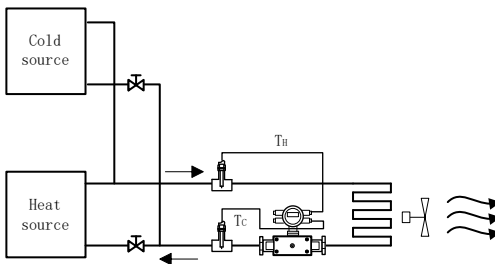

### 2.4 Structure of electromagnetic flowmeter

As can be seen from the figure, the electromagnetic flowmeter mainly consists of the following parts:

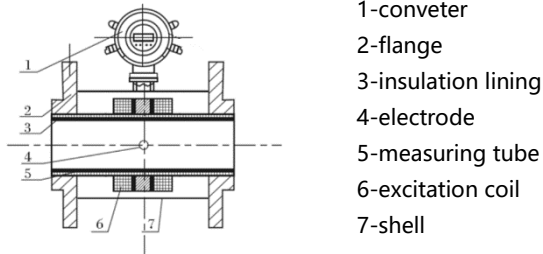

The electromagnetic flowmeter is mainly composed of two parts, the sensor and the converter. The sensors include flange, liner, motor, measuring tube, excitation coil and sensor housing. The converter comprises an internal circuit board and a converter shell.

1. converter: provide stable excitation current for the sensor, at the same time, the induction electromotive force obtained through the sensor is amplified and converted into standard electrical signal or frequency signal. Meanwhile, real-time flow rate and parameters are displayed for the display, control and adjustment of flow.
2. flange: connecting with process piping.
3. insulation lining: a complete layer of electrically insulated corrosion resistant material on the inside of the measuring tube and the flange sealing surface.
4. electrode: A pair of electrodes are installed on the wall of the measuring tube perpendicular to the magnetic force line to detect the flow signal. The electrode material can be selected according to the corrosion performance of the measured medium. There are also 1-2 grounding electrodes for grounding and anti-interference measurement of flow signal.
5. Measuring tube: the measuring tube flows through the measured medium. The measuring tube is welded with non-magnetic stainless steel and flanges lined with insulation lining.
6. excitation coil: the measuring tube is equipped with a set of coils on the outside and below to generate the working magnetic field.
7. shell: plays a role of protection instrument and sealing role.

### 2.5 Use environment description

Electromagnetic flowmeter applies only to measure the instantaneous flow rate of an electrically conductive liquid or liquid-solid two-phase flow, and has a flow accumulation function. Typically, the meter factory parameters will vary depending on the requirements of the order set in advance, the user does not need to set parameters before use, but requires the user to the nameplate on the pre-use check whether the parameters have been set up in advance, and with the actual working conditions do check.

Theoretically medium conductivity of not less than  $5\mu\text{S} / \text{cm}$  can use ordinary type electromagnetic flowmeter  $\text{cm}$ , but the fact that ordinary electromagnetic flowmeter can measure the electrical conductivity higher than the theoretical value should be one to two orders of magnitude, at least more than  $30\mu\text{S} / \text{cm}$  . Meanwhile conductivity measurement must be online measured conductivity prevail, there will be off-line measurement of air carbon dioxide, nitrogen dioxide dissolved into the media resulting in higher conductivity.

2.6 Terminal description

**Integrative type**

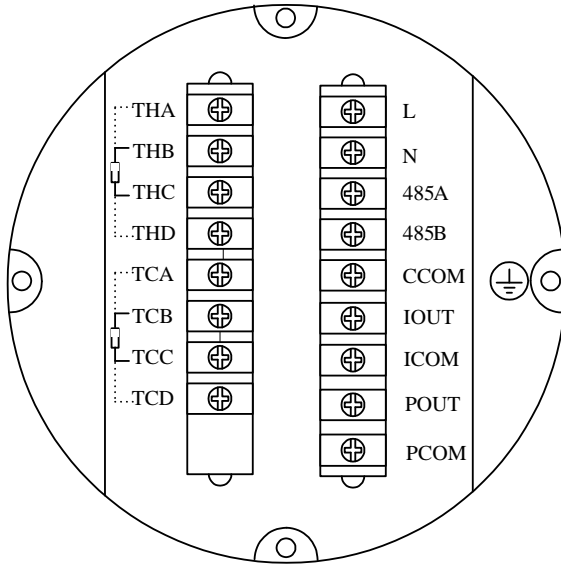

- |   |   |
|---|---|
| L, N:   | 220VAC power supply                       |
| IOUT, ICOM :  | 4-20mA output connection                  |
| POUT, PCOM :  | Pulse/Frequency output                    |
| THA,THB,THC,THD:  | Water supply temperature (Pt1000)         |
| TCA,TCB,TCC,TCD:  | Water return temperature (Pt1000)         |
| 485A,485B :   | 485 serial communication                  |
| CCOM :  | 485 serial communication ground           |
|  : | Converter instrument grounding protection |

## 2.7 Name Plate



### Note!

Please check the name plate of the equipment and confirm whether the power supply is the same as your order and is correct. If incorrect, please contact the manufacturer.

# Energy Meter

MODEL			
RANGE		P MAX	
NORMAL			
FACTOR	T RANGE		ENVIRON
ACCURACY	T DIFF		VOLTAGE
PROTECTION	POSITION		P/N
PRESS LOST	DIRECTION		DATE



KEEP TIGHT WHEN CIRCUIT ALIVE

---

## Chapter 3 Installation

### 3.1 Installation Tips

**Note!**

Please check carefully whether the boxes are damaged .

**Note!**

Please check the packing list to make sure the goods that you receive is complete.

**Note!**

Please check the instrument nameplate, and confirm the delivery item is same with your order. Check the nameplate voltage is correct. If not correct, please contact the manufacturer.

### 3.2 Storage

- The instrument should be stored in a dry and clean place.
- Avoid exposure in direct sunlight for long.
- Instrument should be stored in the original package.

### 3.3 Installation Requirements

**Note!**

In order to ensure the installation reliably , the following measures must be taken.

- Enough space should be spared by its side  
Converter shouldn't be suffered by violent vibration

### 3.4 Piping design



#### **Note!**

The following considerations are taken into account in piping design:

1. place:

The electromagnetic flowmeter should be installed in a dry and ventilated place.

Electromagnetic flowmeter should avoid sun exposure and rain, when installed in the open air, there should be protection against rain and sun protection facilities. The environment temperature is between  $-20\text{ }^{\circ}\text{C} \sim +60\text{ }^{\circ}\text{C}$ .

The electromagnetic flowmeter should avoid being installed in places with large temperature changes and exposed to high temperature radiation of the equipment. If necessary, it should be insulated and ventilated.

The electromagnetic flowmeter should avoid being installed in the environment containing corrosive gas. When installation is necessary, ventilation and anti-corrosion measures should be taken.

The installation site of the electromagnetic flowmeter should avoid strong vibration as far as possible. For example, the vibration of the pipe is large, and there should be a fixed pipe bracket on both sides of the electromagnetic flowmeter.

The sensor part of the electromagnetic flowmeter with IP68(3 meters under water) protection level can be placed in water. The electromagnetic flowmeter with protection class IP65 shall not be immersed in water and installed in the open air.

2. Avoid magnetic field interference:

The electromagnetic flowmeter should not be installed near motors, transformers or other power sources that may cause electromagnetic interference. Electromagnetic flowmeter should not be installed near the converter or get power from the converter distribution cabinet to avoid interference

3. straight pipe section:

In order to ensure the measurement accuracy of the flow meter, it is recommended that the length of the upstream straight pipe segment of the sensor should be at least 5 times the pipe diameter (5D) and the length of the downstream straight pipe segment should be at least 3 times the pipe diameter (3D). (see figure 9 and figure 10).

4. maintenance space:

For the convenience of installation, maintenance and maintenance, sufficient installation space is required around the electromagnetic flowmeter.

5. A pipeline in which flow interruption is not allowed in the process:

The by-pass pipe and cleaning port should be added in the installation of electromagnetic flow timing, as shown in figure 11. This device can guarantee the continuous operation of the equipment system when the meter is out of use.



6. Support of electromagnetic flowmeter:

Do not install the electromagnetic flowmeter in isolation on the freely vibrating pipe, use an installation base to fix the measuring pipe. When the electromagnetic flowmeter needs to be installed in the ground, supports should be set in both the inlet and outlet pipelines, and metal protective plates should be installed on the top of the flowmeter.

**Straight pipe length requirements**

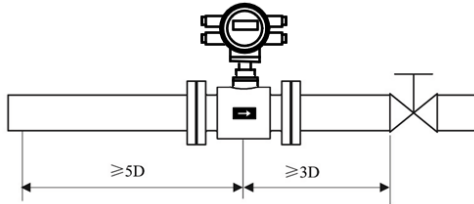

figure 9: Installation whose valve is the downstream of sensor.

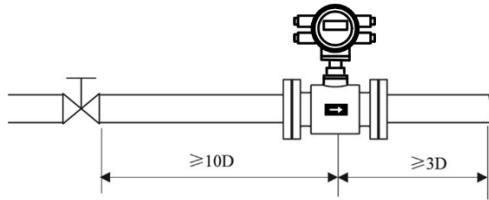

figure 10: Installation whose valve is the upstream of sensor.

**The connection which is easy to clean pipe:**

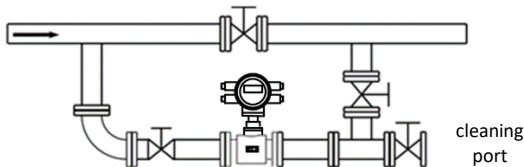

figure 11: Situation where the pipe needs to be cleaned and the fluid conduit cannot stop, you must install a bypass pipe to be able to continue running during cleaning system

## Installation

### 3.5 Sensor installation process

This flowmeter can be set to automatically detect the positive and negative flow direction. The flow arrow on the sensor housing is the positive flow direction specified by the manufacturer. Generally, when installing the instrument, the user should keep the flow arrow in line with the field process flow.

#### Preferred position for electromagnetic flowmeter installation

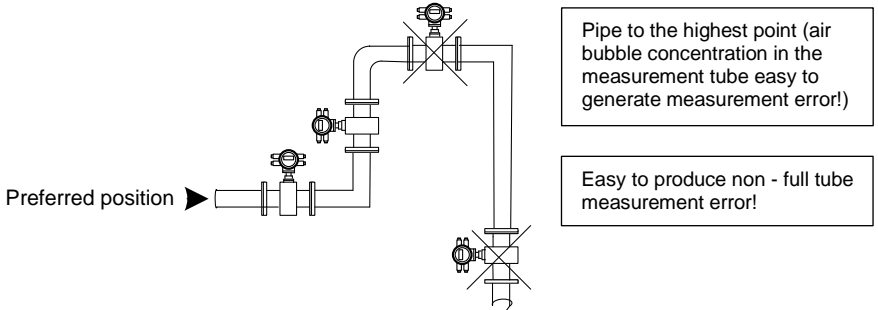

#### Installation direction of electromagnetic flowmeter and installation direction of sensor electrode

Sensors can be installed horizontally and vertically. Sensors in a horizontal when installation should make electrodes in a horizontal position, in this way, once the medium containing bubbles or precipitation, bubble not adsorption in the vicinity of the electrode, converter signal side open, also won't cover the precipitation electrode, the phenomenon such as zero drift.

#### Recommended mounting position

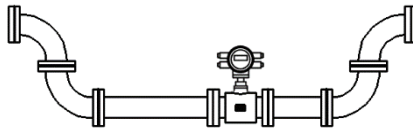

For liquid containing solid particles or the slurry suggestion vertical installation of electromagnetic flowmeter, a can prevent the phase separation of measured medium, the second lining wear can make the sensor is even, three impurities were not able to measure the sediment at the bottom of the tube.

The flow direction must be ensured from the bottom up to ensure that the sensor measurement tube is always filled with media.

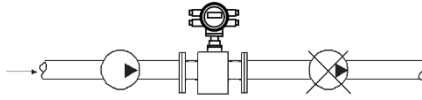
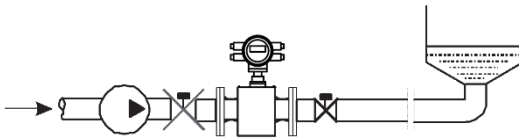
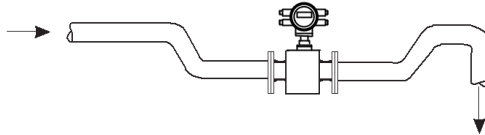

Figure: Electromagnetic flowmeters cannot be installed on the suction side of the pump to prevent the negative pressure produced by vacuum.



Installation that downstream of the sensor has the back pressure.



The electromagnetic flowmeter shall be installed in the bottom section (lower part of the pipe) of the open-drain pipe.

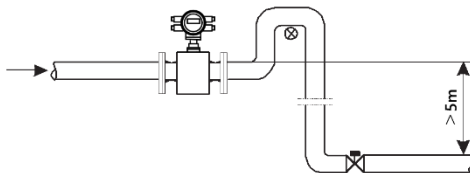

air valves shall be installed downstream of the electromagnetic flowmeter where the pipe drop exceeds 5 meters

# Installation

---

## no bubbles in the pipe

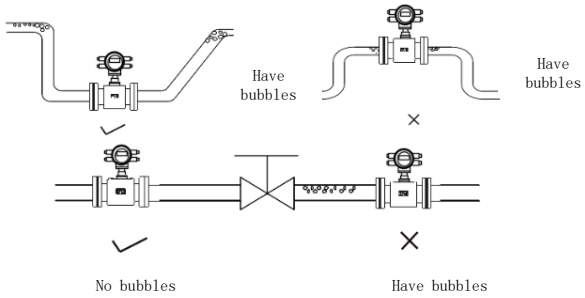

The piping design shall ensure that no gas is separated from the liquid

The flowmeter should be installed upstream of the valve because the pressure in the pipe will be reduced due to the action of the valve, resulting in bubbles

At the same time, instruments should be installed in the lower section to reduce the influence of entrained air bubbles on the measurement

### 3.6 Heat meter installation requirements

1. The pipe must be cleaned before the heat meter is installed.
2. The heat meter is a precision instrument. It must be installed carefully. Do not squeeze the temperature sensor to prevent damage to the instrument.
3. The direction indicated by the arrow of the sensor body of the heat meter indicates the direction of water flow.
4. The front end of the heat meter pipe must be equipped with a corresponding caliber filter.
5. When installing the heat meter flow sensor, it is necessary to ensure that the water flow direction of the heat meter pipe is at least 10 times the pipe diameter of the straight pipe upstream and at least 5 times the pipe diameter downstream.

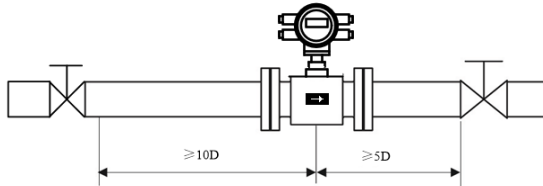

6. The two ends of the heat meter must be equipped with valves of corresponding caliber, which can be separated from the heat meter for cleaning and maintenance of the heat meter in use.
7. The heat meter has a pair of temperature sensors used at the inlet and outlet respectively. Install the red label temperature sensor on the inlet pipe and the blue label temperature sensor on the outlet pipe. Temperature sensor probe inserted into the pipe position should be in the center of the pipe cross section (temperature sensor insert as shown in the figure below there are three ways: 1. temperature sensor sheath, 2. pipe opening, 3. pipe cross section, 4. temperature sensor probe)

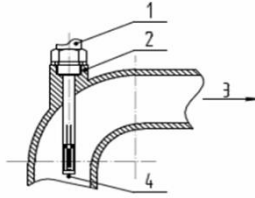

Bend pipe insertion way

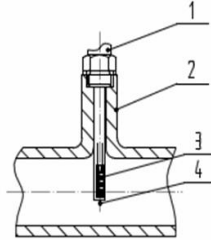

Straight pipe insertion way

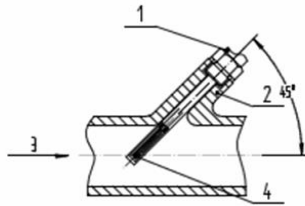

diagonal pipe insertion way

8. The standard line of temperature sensor is 3 meters long, which can be lengthened according to the actual length when installing. When ordering, the manufacturer should be informed of the situation.

9. After the installation of the heat meter, each connection should be sealed, especially when the sensor is inserted into the pipe

### 3.7 Machinery installation



#### Note!

We don't supply installation materials and tools. Please use installation materials and tools that meet the occupational health standards and conform to safety regulations.

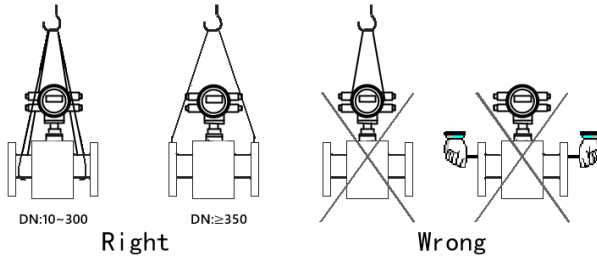

#### Installation of flowmeter pipe

1. Before installing the flowmeter, the pipeline should be calibrated to ensure that the meter's diameter has a good coaxial degree with the user's pipeline. For sensors with nominal through-diameter under 50mm, the axis of the sensor shall not exceed 1.5mm on the high side, the nominal through-diameter between 65-300mm shall not exceed 2mm, and the nominal through-diameter between 350mm and above shall not exceed 4mm.

2. The newly installed pipe usually has foreign matter (such as welding slag). Before installing the flowmeter, the sundries should be washed away, which can not only prevent the lining from being damaged, but also prevent the measurement error caused by the foreign matter passing through the measuring tube during the measurement period.

## Installation

### 3.8 Dimensions of the pipeline electromagnetic flowmeter

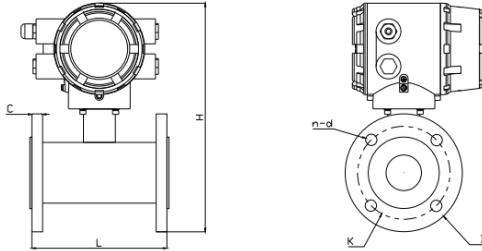

Nominal Diameter (mm)	Nominal pressure (MPa)	Connection dimension (mm)						
		L	H	D	K	d	n	C
15	4.0	200	315	95	65	14	4	14
20		200	315	105	75	14	4	16
25		200	315	115	85	14	4	16
32		200	315	140	100	18	4	18
40		200	315	150	110	18	4	18
50		200	320	165	125	18	4	20
65	1.6	200	350	185	145	18	8	22
80		200	365	200	160	18	8	24
100		250	380	220	180	18	8	22
125		250	410	250	210	18	8	22
150		300	440	285	240	22	8	24
200	1.0	350	495	340	295	22	8	24
250		450	560	395	350	22	12	26
300		500	600	445	400	22	12	26
350		550	670	505	460	22	16	30
400		600	720	565	515	26	16	32
450		600	765	615	565	26	20	36
500		600	820	670	620	26	20	38
600		600	930	780	725	30	20	42
700	0.6	700	1010	860	810	26	24	40
800		800	1110	975	920	30	24	44
900		900	1210	1075	1020	30	24	48
1000		1000	1310	1175	1120	30	28	52
1200		1200	1540	1405	1340	33	32	60



Converter size:

Linear Measure: mm

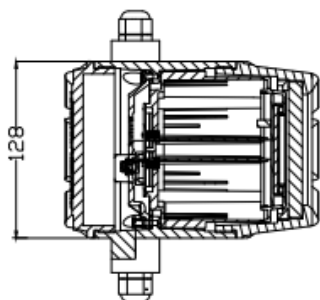
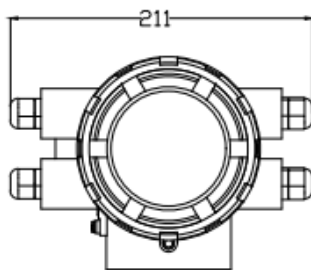
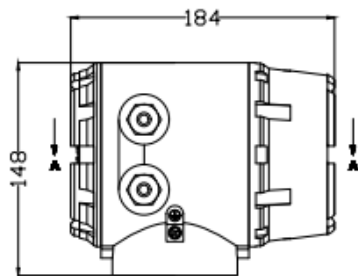

## Chapter 4 Electrical Connection

### 4.1 Safety Tips

#### **Danger!**



Only when power is switched off, can we do all the work about electrical connections. Please pay all attention to the power supply on the name plate!

#### **Danger!**



Please observe national installation regulations

#### **Danger!**



Please strictly observe local occupational health and safety regulations.  
Only those who have got properly trained are allowed to operate on the electrical equipment.

#### **Tips!**



Please check the name plate of the equipment, and confirm whether the supply is the same as your order. Check whether voltage and E-supply on the nameplate is correct. If incorrect, please contact manufacturers.

### 4.2 Connect Signal and Magnetic Field Current Cable



**Danger!**

Only when power is cut off can you connect signal and magnetic field current conductor.



**Danger!**

The equipment must be grounded in accordance with regulations so as to protect the operator from electrical shock.



**Danger!**

In case that equipment be used in explosion danger areas, special notes are given to explosion-proof instructions for safety tips.



**Warning!**

Please strictly observe local occupational health and safety regulations. Only those who have got properly trained are allowed to operate on the electrical equipment.

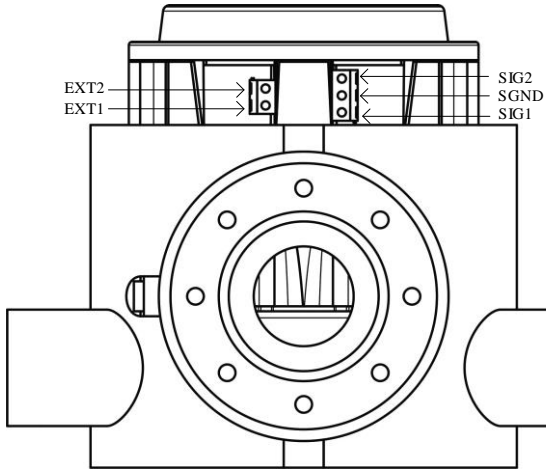

### Connection illustration

- Excitation line:
  - EXT1-- Sensor excitation coil positive terminal
  - EXT2--Sensor excitation coil negative terminal
- Signal line
  - SIG1--- The positive electrode sensor signal
  - SIG2--- The negative electrode sensor signal
- SGND-- Signal ground

### 4.3 Measurement Sensor Ground



**Danger!**

There allows no permission of potential difference between measurement sensor and housing or converter protection ground.

- Measurement sensor must be fully grounded
- Grounding conductor should not transfer any disturbing voltage.
- Grounding conductor is not allowed to be connected to other electrical equipment at the same time.

## 4.4 Connected to Power



### Danger!

The equipment must be grounded in accordance with regulations so as to protect the operator from electrical shock.

### 220VAC Power Supply

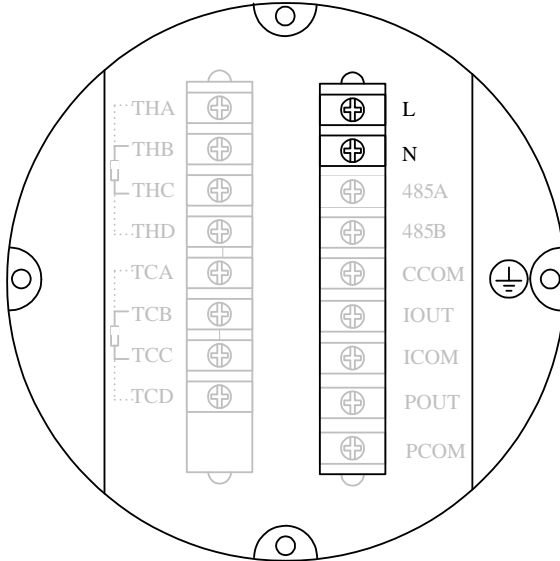

### Tips!

Including allowed band: 100VAC -240VAC, 50Hz-60Hz

- L: AC phase line;
- N: AC neutral line;
-  : Connect ground wire to the ground screw.

24VDC Power Supply

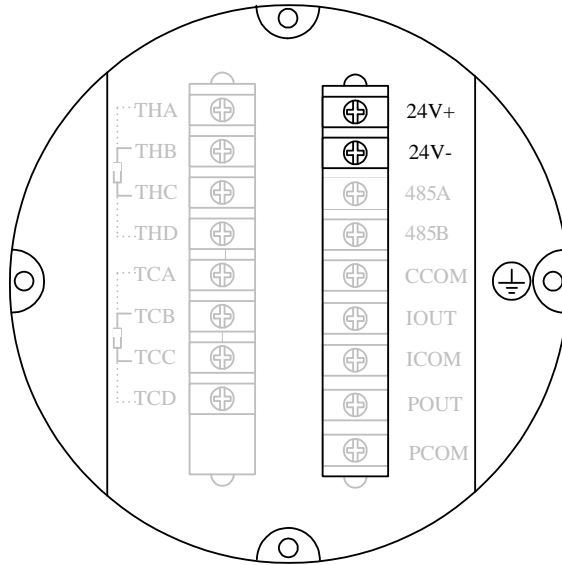

**Tips!**

Allowance range: 22VDC -26VDC

- 24+:Power supply positive pole;
- 24-:Power supply negative pole.

4.5 Input introduction

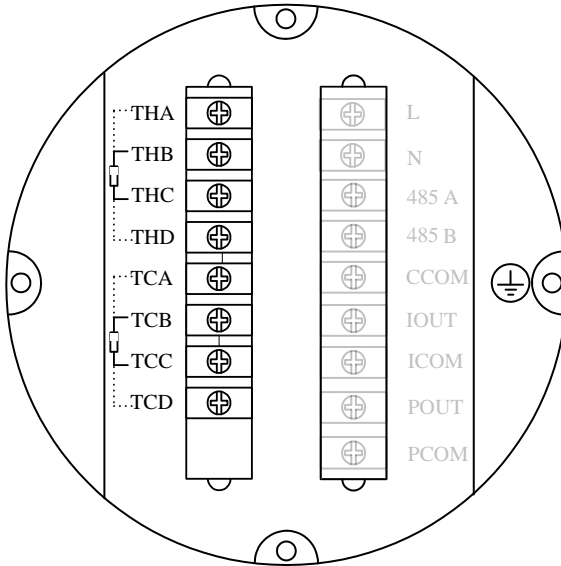

**Supply and return water temperature input**

- THA, THB, THC, THD: Supply water temperature sensor inputs PT1000
- TCA, TCB, TCC, TCD: Return water temperature sensor inputs PT1000

Connection mode of 4-wire

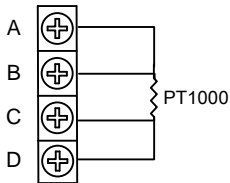

Connection mode of 2-wire

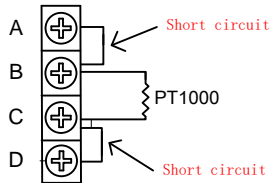

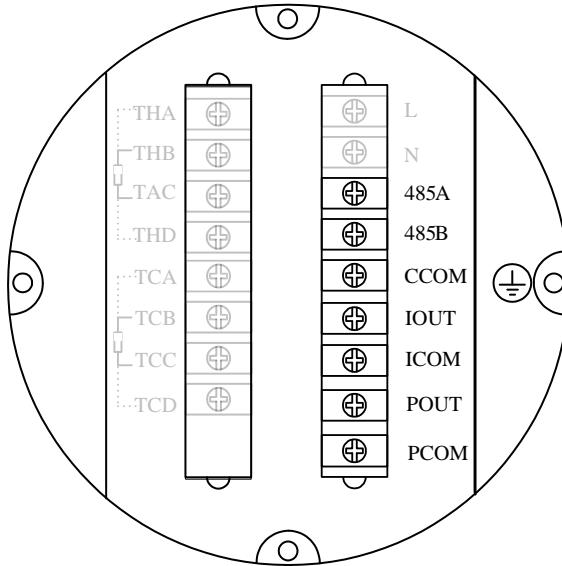

## 4.6 Output introduction

**Current Output**

- IOU、ICOM: 4-20mA output
- Active mode: when load  $R_L \leq 750\Omega$ ;  $I_{max} \leq 22mA$
- Current flow percent

**Communication output**

- 485A、485B: 485 Serial communication output;
- CCOM: 485 Serial communication ground;
- Agreement: ModBus-RTU.

# Electrical Connection

## Pulse, Frequency and Alarm output

- Corresponding terminal is POUT、PCOM
- Active mode: High 24V, 5mA drive current
- Output electrical isolation: photoelectric isolation, isolation voltage: > 1000VDC;
- Scale:  
Frequency output: Frequency 2KHz(configurable 0-5kHz)  
Corresponding to the upper limit of the flow range;  
Pulse output: corresponding flow rate volume of each pulse (configurable), output Pulse width: 0.1ms ~100ms, duty cycle 1:1,  $F_{max} \leq 5000$  cp/s;
- Elementary diagram:

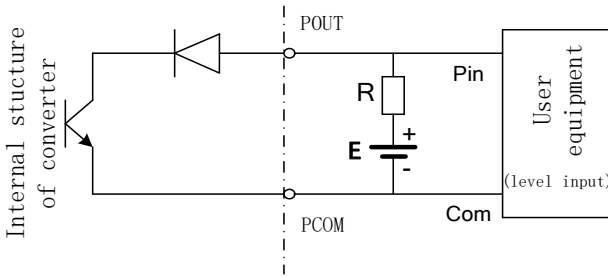

Additional remarks : pulse output for OC gate output, need external power supply. General counter all wear resistance, signal can be directly connected to the counter.

Manufacturer recommendations: upper pull resistance R is recommended to use 2 k, 0.5 W resistor, another power E recommended 24 v dc power supply.

## Chapter 5 Startup

### 5.1 Power on

Please check whether the instrument installation is correct before power on including :

- The meter must be installed under safety compliance.
- Power supply connection must be performed in accordance with the regulation.
- Please check the electrical connection in the power supply is correct.

Tighten the converter shell back cover

### 5.2 Converter startup

Measuring instrument consists of measuring sensor and signal converter, the supply has been already in a state of putting-in-service.

All the operation data and engineering contents have been set according to customer order. It will have a self-check after turning on the power supply. After that, measuring instrument will immediately begin to measure and display the current values.

Startup picture

Heat screen

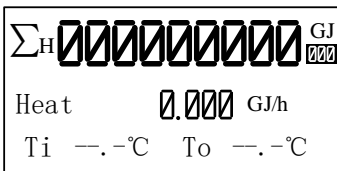

Flow screen

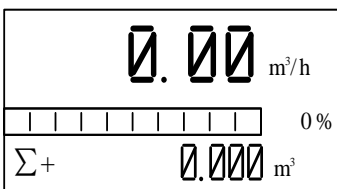

Chapter 6 Operation

6.1 Heat display and operation Button

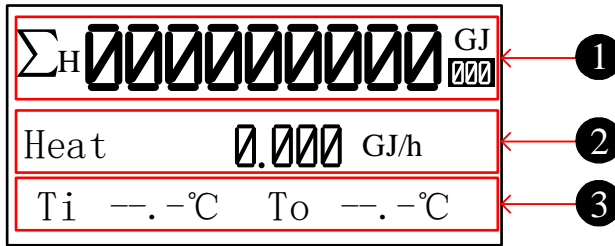

1. Energy line 1

Default: Accu heat

Optional: Accu heat, Accu cold and Heat.

Optional (loop): Accu heat, Accu cold, Heat and OFF.

2. Energy line 2

Default: Heat

Optional: Heat,  $T_{in}$  and  $T_{out}$ ,  $T_{in}$ ,  $T_{out}$ , TD, Flow, Accu heat, Accu cold, Accu fwd, Accu rev, Accu net, Flow vel, MT, Shut num, Shut time, Run time and Real time.

Optional (loop): Heat,  $T_{in}$  and  $T_{out}$ ,  $T_{in}$ ,  $T_{out}$ , TD, Flow, Accu heat, Accu cold, Accu fwd, Accu rev, Accu net, Flow vel, MT, Shut num, Shut time, Run time, Real time and OFF.

3. Energy line 3

Default:  $T_{in}$  and  $T_{out}$

Optional:  $T_{in}$  and  $T_{out}$ ,  $T_{in}$ ,  $T_{out}$ , TD, Flow, Accu heat, Accu cold, Accu fwd, Accu rev, Accu net, Flow vel, MT, Shut num, Shut time, Run time, Real time and Heat.

Optional (loop):  $T_{in}$  and  $T_{out}$ ,  $T_{in}$ ,  $T_{out}$ , TD, Flow, Accu heat, Accu cold, Accu fwd, Accu rev, Accu net, Flow vel, MT, Shut num, Shut time, Run time, Real time, Heat and OFF.

Tips: Heat-related parameters can press  $\leftarrow$  key to switch between.

Heat display can press  $\triangleright$  buttons to switch the screen to Flow display.

6.2 Flow display and operation Button

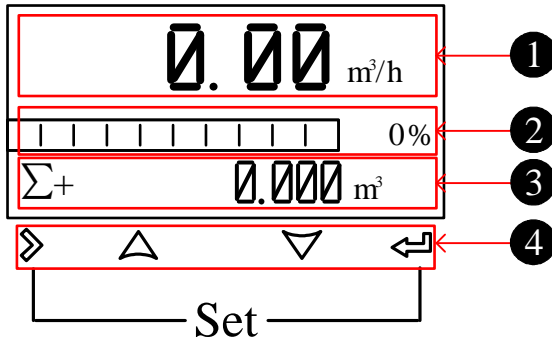

1. Flow line 1

Default: Flow

Optional: Flow, Accu fwd ( $\Sigma+$ : Positive flow accumulation), Accu rev ( $\Sigma-$ : Negative flow accumulation) and Accu net ( $\Sigma$ : Net flow accumulation).

Optional (loop): Flow, Accu fwd, Accu rev, Accu net and OFF.

2. Flow line 2

Default: Flow bar

Optional: Flow bar, Accu fwd, Accu rev, Accu net, Flow vel (current flow rate) and MT (current conductivity).

Optional (loop): Flow bar, Accu fwd, Accu rev, Accu net, Flow vel, MT and OFF.

3. Flow line 3

Default: Accu fwd

Optional: Flow bar, Accu fwd, Accu rev, Accu net, Flow vel and MT.

Optional (loop): Flow bar, Accu fwd, Accu rev, Accu net, Flow vel, MT and OFF.

## Operation

Tips:

1. You can modify the parameters of [flow/energy line 1/2/3] and [flow/energy line 1/2/3 loop] in flow configuration 12, and the cycle interval of each parameter is 10s.
2. When alarm occurs, the cycle interval of the alarm information (including empty pipe, high flow alarm, low flow alarm, overrun pulse limit alarm and overrun flow limit) screen is 5S and the duration is 2S. This information occupies flow line 2 and 3 in the display screen, as shown in the following figure.

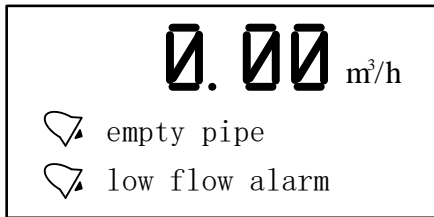

#### 4. Operation keys: mechanical keys

Signal	Measuring Mode	Menu Mode	Function Mode	Data Mode
➤	-	switch menu categories	-	Data right shift
↩	Switch accumulative amount	Switch menu subclass	confirmation	Confirm data
△ ▽	-	-	selection	Change data
➤ + ↩	Enter menu	Exit menu	-	-

### 6.3 Operating instructions for mechanical keys

Please open the converter cover before handling mechanical keys.

Mechanical key to enter configuration mode operation as shown in the next section.

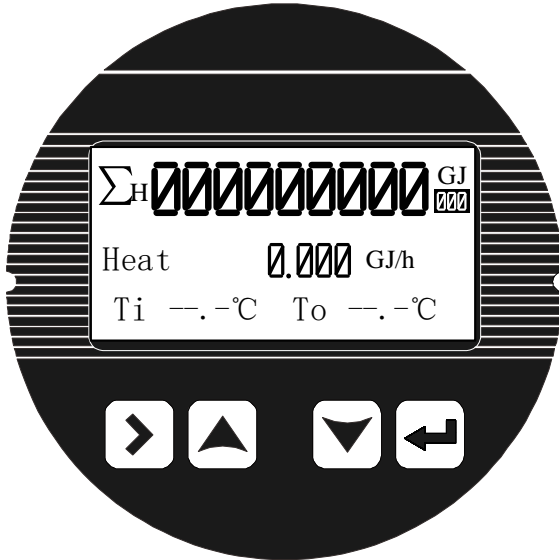

# Operation

## 6.4 Operating instruction

### Parameter selection and adjustment

Press  $\triangleright$  and  $\triangleleft$  together, enter into parameter setting interface .

Password need to be input by then

**Initial users password: 200000 (used for modifying the user level parameter )**

**Initial manufacture password:100000 (used for modifying the manufacture level parameter)**

**Initial manufacture password:300000 (to set up parameter quickly )**

After entering the configuration parameters , the parameters can be modified by the following operation :

User can conduct the switch operation in the menu by pressing the  $\triangleright$  button , switch among the parameter item of menu by pressing the  $\triangleleft$  button, and store a modified parameter value at the same time , adjust the parameter value by pressing the  $\wedge$  and  $\vee$  buttons.

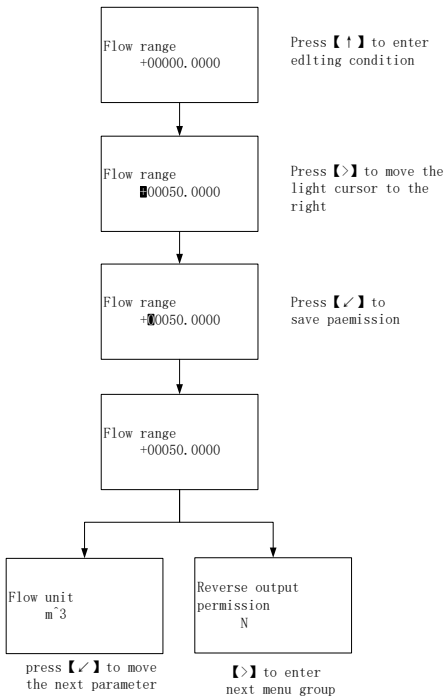



Flow setup and analog output menu

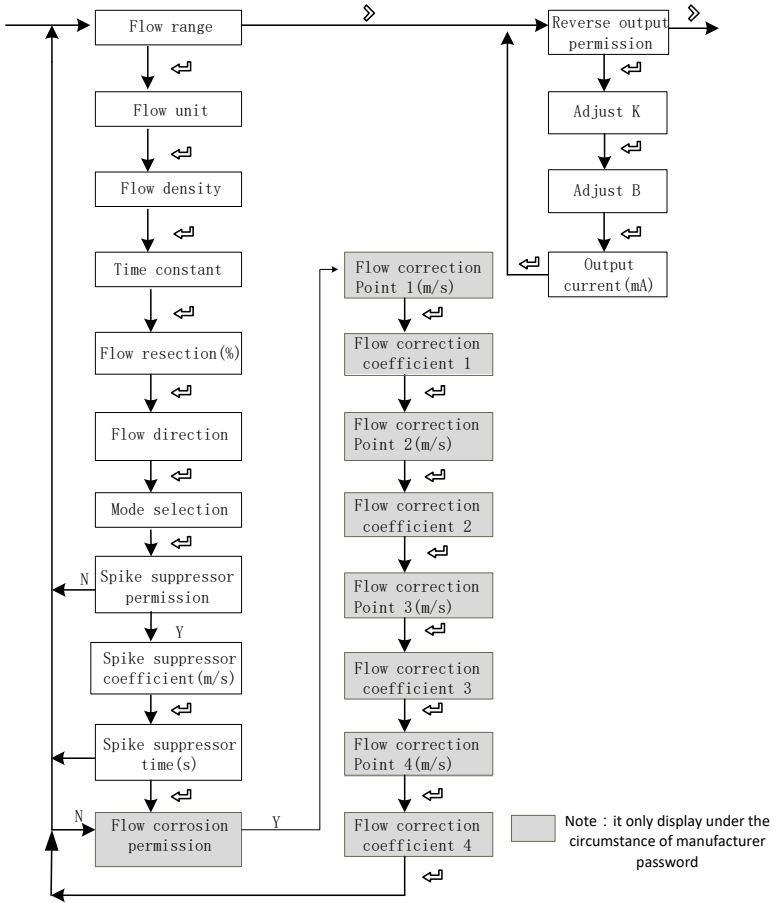

## Pulse output and total set menu

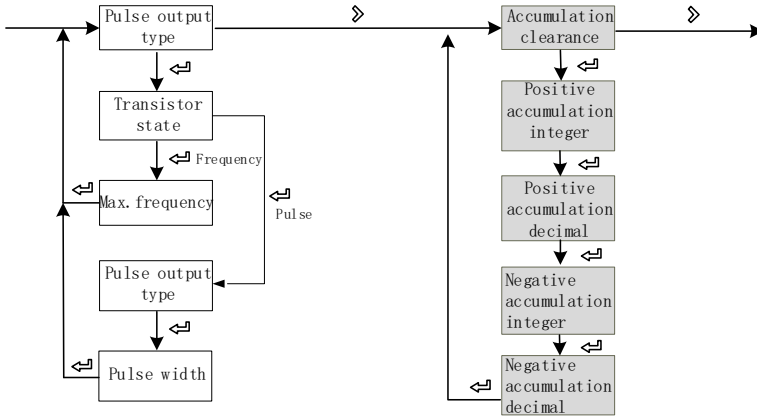

Note : it only display under the circumstance of manufacturer password

## Alarm setup menu

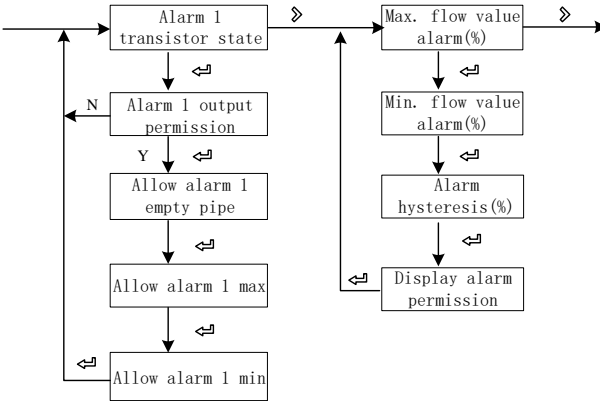

**System function, empty pipe function , sensors function, test function setup**

**menu**

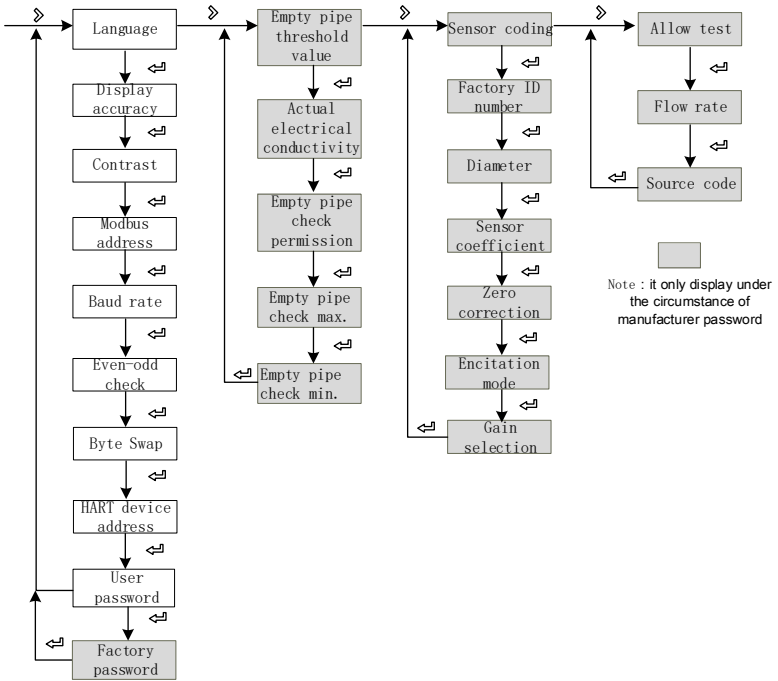

**Thermal function menu**

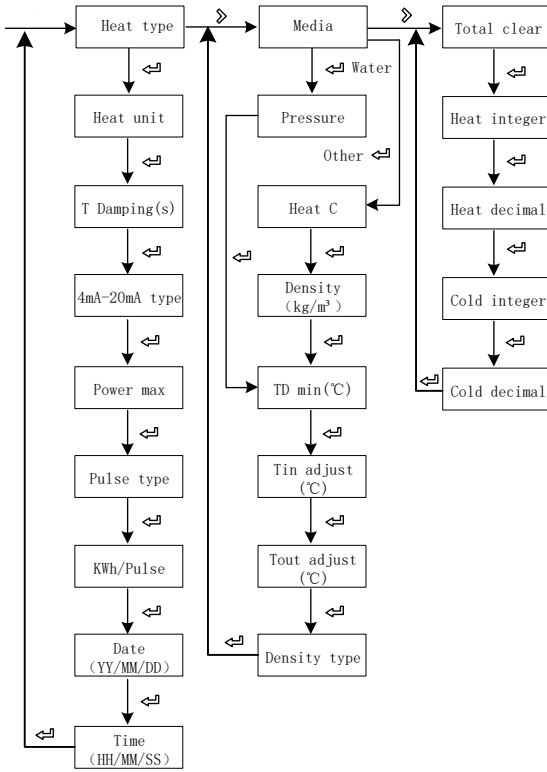

6.5 Configuration details

NO.	Parameter	Setting mode	Password level	Parameter range	Default
1-Flow rate					
1-0	Flow range	Figure	User	0-99999	35.000
	Set the maximum flow limit value. Used to calculate the frequency, output current limit calculation; Alarm threshold calculation, etc				
1-1	Flow unit	Option	User	L, m <sup>3</sup> , Kg, t, gal, lgal /s, min, h	m <sup>3</sup> /h
	Choose L, m <sup>3</sup> , gal, lgal such as volume unit, the density will not participate in calculation; Choose Kg, t, such as mass unit, need to cooperate with 1-2 density parameter.				
1-2	Fluid density	Figure	User	0.000-99.000	1.000
	Used to calculate the mass flow rate, $QM = \rho V_M$ when flow volume unit is volume unit t, this parameter will not be displayed. Density of the unit : g/cm <sup>3</sup>				
1-3	Time constant	Figure	User	0-99S	2s
	Damping coefficient of the filter, select the parameters of the selected period of time as the average of the instantaneous flow				
1-4	Flow resection	Figure	User	0-10%	1%
	Flow volume is regarded as zero if it is below the setting value Zero means not remove				
1-5	Flow direction	Option	User	Positive, Negative	Positive
	Used to change the direction of flow, when the user signal lines negative pole and positive pole are reverse connection, or reverse sensor installation, use this feature				
1-6	Mode selection	Option	User	Positive,Negative Bidirection	positive
	Set the direction of the flow measurement, forward direction indicates only for forward direction measurement flow, reverse indicate only measure the reverse flow, two-way indicate two-way flow measurement				
1-7	spike suppressor permission	Option	User	Y, N	N
	Indicate whether to enable peak inhibition function, this function is applied to the operation condition of the larger jamming signal , is used to filter the jamming signal. When set to N doesn't show 1-8, 1-9 configuration screen. When the range of the signal pulse is greater than 1-8 sets parameters and the time duration is less than 1-9 set time, the system will consider it an interference signal and will not display and measure .				

## Operation

1-8	spike suppressor coefficient	Figure	User	0.01-0.8m/s	0.8
	The peak amplitude (it is not shown when peak inhibition allows configuration closing )				
1-9	spike suppressor time	Option	User	0-3s	1
	Peak duration time(it is not shown when peak inhibition allows configuration closing )				
1-10	Flow correction permission	Option	User	Y、 N	N
	<p>Indicates whether start using flow nonlinear correction function.In principle, used for small flow rate less than (0.5 m/s) linear adjustment</p> <p>The functional design with 4 period of correction, is divided into four flow point and correction coefficient.Thecorresponding velocity of correction point must meet :</p> <p>Correction point 1 ≥ Correction point 2 ≥ Correction point 3 ≥ Correction point 4 ≥ 0.</p> <p>Correction calculation is conducted on the original sensor flow coefficient curve correction, therefore, should be closed nonlinear correction function, mark sensor coefficient. Then allow the nonlinear correction function, according to the nonlinear of sensor, setting correction coefficient, piecewise corrected. If the coefficient is set right, no need to calibration.</p> <p>The original velocity stand for the real standard velocity, the revised flow velocity is called modified velocity, the modified computation formula is as follows:</p> <p>At the interval of the modified point 1 &gt; The original flow velocity ≥ The modified point 2</p> <p style="padding-left: 40px;">The modified flow velocity = Correction factor 1 × The original flow velocity</p> <p>At the interval of the modified point 2 &gt; The original flow velocity ≥The modified point 3</p> <p style="padding-left: 40px;">The modified flow velocity = Correction factor 2 × The original flow velocity</p> <p>At the interval of the modified point 3 &gt; The original flow velocity ≥ The modified point 4</p> <p style="padding-left: 40px;">The modified flow velocity = Correction factor 3× The original flow velocity</p> <p style="padding-left: 40px;">At the interval of the modified point 4 &gt; The original flow velocity ≥ 0</p> <p style="padding-left: 40px;">The modified flow velocity = Correction factor 4× The original flow velocity</p> <p>Note: when set the modified point, should keep the following relationshipModified point 1 &gt; Modified point 2 &gt; Modified point 3 &gt; Modified point 4 &gt; 0The intermediate value of Correction coefficient is 1.0000, if the correction coefficient is greater than 1 , then increase the flow velocity ; if the correction coefficient is less than 1 , then decrease the flow velocity ;</p>				
1-11	Flow correction point 1	Figure	Factory	0.0-99.999	0
	Flow rate modified point 1, when The flow rate function shut down , this parameter does not display.				
1-12	Flow correction coefficient 1	Figure	Factory	0.0-99.999	1.000
	Flow rate correction factor 1, when The flow rate function shut down , this parameter does not display.				

## Operation

1-13	flow correction point 2	Figure	Factory	0.0-99.999	0
	Flow rate modified point 2, when The flow rate function shut down , this parameter does not display.				
1-14	Flow correction coefficient 2	Figure	Factory	0.0-99.999	1.000
	Flow rate correction factor 2, when The flow rate function shut down , this parameter does not display.				
1-15	Flow correction point 3	Figure	Factory	0.0-99.999	0
	Flow rate modified point 3, when The flow rate function shut down , this parameter does not display.				
1-16	Flow correction coefficient 3	Figure	Factory	0.0-99.999	1.000
	Flow rate correction factor 3, when The flow rate function shut down , this parameter does not display.				
1-17	Flow correction point 4	Figure	Factory	0.0-99.999	0
	Flow rate modified point 4, when The flow rate function shut down , this parameter does not display.				
1-18	Flow correction coefficient 4	Figure	Factory	0.0-99.999	1.000
	Flow rate correction factor 4, when The flow rate function shut down , this parameter does not display.				

## Operation

2-Current output					
2-0	Reverse output permission	Option	User	Y , N	N
	When Flow rate is reverse ,whether 4-20 ma output is needed , pulse/frequency; Flow rate is forward , It cannot be shut down				
2-1	Adjust K	Figure	User	-99.999~99.999	01.000
	Used for adjusting the output current value , $I = Kx + B$				
2-2	Adjust B	Figure	User	-99.999~99.999	00.000
	Used for adjusting the output current value , $I = Kx + B$				
2-3	Output current	Display	User	4.00-20.00	--
	Display the current output of current value(mA)				
3- Pulse/frequency/alarm output					
3-0	Pulse output type	Option	User	Frequency, Pulse, Alarm (integrated)	Frequency
	Optional frequency ,pulse equivalent/alarm output				
3-1	Max. frequency	Figure	User	0-5000	2000
	Set the corresponding value of the instantaneous flow upper limit ; when select for frequency output , this parameter display .				
3-2	Pulse value(L/P)	Option	User	0.001-999.999	1.0
	Set the the cumulant that each pulse stand for ; When selecting is the equivalent output, this parameter display.				
3-3	Pulse width	Option	User	10ms、20ms、50ms、100ms、200ms、50%	100ms
	SetPulse width.				
3-4	Pulse width (ms)	Option	User	10ms、20ms、50ms、100ms、200ms、50%	100ms
	Set Pulse width. When selecting is the pulse output, this parameter display.				



4-Accumulation					
4-1	Accumulation clearance	Option	Factory	Y、N	N
	Clear accumulation amount				
4-2	Positive accumulation integer	Figure	Factory	0-999999999	0
	Set total positive integer part				
4-3	Positive accumulation decimal	Figure	Factory	0.0-0.999	0.0
	Set total positive decimal part				
4-4	Negative accumulation integer	Figure	Factory	0-999999999	0
	Set reverse total integer part				
4-5	Negative accumulation decimal	Figure	Factory	0.0-0.999	0.0
	Set reverse total decimal part				
5-Alarm contacts 1					
5-1	Alarm1 output permission	Option	User	Y/N	N
	Allow touch spot 1 output main switch , when set to N, the following parameters do not display.				
5-3	Allow alarm1 empty pipe	Option	User	Y/N	N
	Allow empty pipe alarm output switch, the system detects empty pipe, contact 1 output alarm signal automatically. When allowed alarm output configuration as N, this parameter does not display.				
5-4	Allow alarm1 max.	Option	User	Y/N	N
	Allow flow rate upper limit alarm output switch , when the instantaneous flow is greater than the flow rate lower limit value, touch spot 1 output alarm signal automatically. The instructions are specific Settings in 7-1. When allowed to alarm output configuration for N, this parameter is not displayed.				
5-5	Allow alarm1 min.	Option	User	Y/N	N
	Allow flow rate lower limit alarm output switch , when the instantaneous flow is less than the flow rate lower limit value, touch spot 1 output alarm signal automatically. The instructions are specific Settings in 7-2. When allowed to alarm output configuration for N, this parameter is not displayed.				

# Operation

7-Alarm setup					
7-0	Max. flow value alarm	Figure	User	0-999.9%	100%
	Set the upper limit alarm value, measuring range percentage				
7-1	Min. flow value alarm	Figure	User	0-999.9%	0%
	Set the lower limit alarm value, measuring range percentage				
7-2	Alarm hysteresis	Figure	User	0-99.9%	1%
	Used to eliminate the alarm when the disturbance				
	Upper limit elimination conditions: instantaneous flow is less than the upper limit alarm value – return difference Lower limit elimination conditions: instantaneous flow is greater than the upper limit alarm value + return difference				
7-3	Display alarm permission	Option	User	Y/N	N
	Allows the alarm message display onto to the main picture switch				

## Operation

8-System					
8-0	Language	Option	User	Chinese/English	Chinese
	Set configuration display language				
8-1	Display accuracy	Figure	User	0-4	2
	The instantaneous volume of decimal digits				
8-2	Contrast	Figure	User	0-100%	50%
	Contrast ratio of Liquid crystal display				
8-3	Modbus address	Figure	User	1-247	8
	Communication agreement instrument address Based on the RS485 protocol Modbus RTU				
8-4	Baud rate	Option	User	1200、2400、 4800、9600、 19200、38400、 57600	9600
	Baud rate of serial communication verification mode				
8-5	Even-odd check	Option	User	NONE/ODD/ EVEN	NONE
	Serial communication verification mode of physical layer				
8-6	Byte Swap	Option	User	2-14-3、3-41- 2、4-31-2、1- 23-4	2-1 4-3
	Byte switching order for serial communication at the physical layer				
8-7	Device address	Figure	User	0-999999	000001
	HART equipment identification number				
8-8	User password	Figure	User	000000-999999	000000
	User-level password for viewing and modifying user-level parameter configurations, This parameter is not displayed when entered with the manufacturer password, User initial password: 200000				
8-9	Factory password	Figure	Factory	000000-999999	000000
	Factory -level password for viewing and modifying factory -level parameter configurations, Factory initial password: 100000				

## Operation

9-Empty tube parameters					
9-0	Empty pipe threshold value	Figure	Factory	0-100%	50%
	Empty tube alarm judgement gate value				
9-1	Actual electrical conductivity	Display	Factory		
	<p>Display the measured conductivity equivalent of the fluid.</p> <p>For general natural water: equivalent &lt; 200 when tube is full, when empty tube &gt; 200 ( the equivalent is related to the fluid conductivity and the length of measuring line , it is recommended double shielded wire is used when the wiring distance is 20m , otherwise it will affect empty detection function .</p>				
9-2	Empty pipe check permission	Option	Factory	Y , N	Y
	Set whether open empty detection function				
9-3	Empty pipe check max.	Figure	Factory	0-9999	1200
	Measured conductivity equivalent value when the tube is empty, default values can be used for general natural water. which need to observe the empty wipe for special fluid is 9-1 value, write in 9-3				
9-4	Empty pipe check min.	Figure	Factory	0-9999	200
	Measured conductivity equivalent value when the tube is full, default values can be used for general natural water. which need to observe the empty wipe for special fluid is 9-1 value, write in 9-4				
9-5	Empty pipe check hysteresis	Figure	Factory	0-9999	30
	Hysteresis value for empty pipe check, default values can be used within 20 meters of the signal line.				

## Operation

10-Sensor					
10-0	Sensor coding	Figure / symbol	Factory	16 digital	
	Used for identify sensors				
10-1	Factory ID number	Figure	Factory	6 digital	
	Identification number				
10-2	Diameter	Option	Factory	3-2000	50
	Sensor size				
10-4	Sensor coefficient	Figure	Factory	0-99.99999	01.0000 0
	The flowmeter coefficient was calibrated according to the actual flow volume by sensor manufacture For details, see sensor coefficient calibration section				
10-6	Zero correction	Figure	Factory	-9.9999~9.9999	+0.0000
	Sensor nonlinear correction when used for small flow (below 0.3 m/s) V is the real-time flow rate displayed above, V (after correction) = V (before correction) + zero correction value				
10-7	Excitation mode	Option	Factory	3.125Hz、6.25 Hz、 12.5 Hz、25 Hz	6.25Hz
	The choice of excitation frequency: 3.125Hz 、 6.25Hz、 12.5Hz、 25 Hz				
10-9	Gain selection	Option	Factory	1/3/9	3
	Gain choice: adjust the gain can change the range of flow speed Gain adjustment : 1、 3、 9				
11-Test					
11-0	Allow	Option	Factory	Y/N	N
	Set Y allow simulate velocity, After the power failure automatically restored to N.				
11-1	Simulate velocity (m/s)	Figure	Factory	-12.000~12.000	1.000
	Set value of simulate velocity, "11-0 allow test" should be set to "Y"				
11-2	Simulate code	Option	Factory	Y/N	N
	After setting Y, the original signal code will be displayed in the running screen. This screen also displays the firmware version and product serial number.				

## Operation

12-Display					
12-0	Flow line 1	Option	User	Flow, Accu fwd, Accu rev, Accu net	Flow
	A parameter can be selected as the display parameter of flow line 1.				
12-1	Flow line 1 loop	Option	User	Flow, Accu fwd, Accu rev, Accu net, OFF	OFF
	You can turn off or select another parameter as the loop display parameter of flow line 1				
12-2	Flow line 2	Option	User	Flow bar, Accu fwd, Accu rev, Accu net, Flow vel, MT	Flow bar
	A parameter can be selected as the display parameter of flow line 2.				
12-3	Flow line 2 loop	Option	User	Flow bar, Accu fwd, Accu rev, Accu net, Flow vel, MT, OFF	OFF
	You can turn off or select another parameter as the loop display parameter of flow line 2.				
12-4	Flow line 3	Option	User	Flow bar, Accu fwd, Accu rev, Accu net, Flow vel, MT	Accu fwd
	A parameter can be selected as the display parameter of flow line 3.				
12-5	Flow line 3 loop	Option	User	Flow bar, Accu fwd, Accu rev, Accu net, Flow vel, MT, OFF	OFF
	You can turn off or select another parameter as the loop display parameter of flow line 3.				
12-6	Energy line 1	Option	User	Accu heat, Accu cold, Heat	Accu heat
	A parameter can be selected as the display parameter of energy line 1.				
12-7	Energy line 1 loop	Option	User	Accu heat, Accu cold, Heat, OFF	OFF
	You can turn off or select another parameter as the loop display parameter of energy line 1				

## Operation

12-8	Energy line 2	Option	User	Heat, Tin and Tout, Tin, Tout, TD, Flow, Accu heat, Accu cold, Accu fwd, Accu rev, Accu net, Flow vel, MT, Shut num, Shut time, Run time, Real time	Heat
	A parameter can be selected as the display parameter of energy line 2.				
12-9	Energy line 2 loop	Option	User	Heat, Tin and Tout, Tin, Tout, TD, Flow, Accu heat, Accu cold, Accu fwd, Accu rev, Accu net, Flow vel, MT, Shut num, Shut time, Run time, Real time, OFF	OFF
	You can turn off or select another parameter as the loop display parameter of energy line 2.				
12-10	Energy line 3	Option	User	Heat, Tin and Tout, Tin, Tout, TD, Flow, Accu heat, Accu cold, Accu fwd, Accu rev, Accu net, Flow vel, MT, Shut num, Shut time, Run time, Real time	Tin and Tout
	A parameter can be selected as the display parameter of energy line 3.				
12-11	Energy line 3 loop	Option	User	Heat, Tin and Tout, Tin, Tout, TD, Flow, Accu heat, Accu cold, Accu fwd, Accu rev, Accu net, Flow vel, MT, Shut num, Shut time, Run time, Real time, OFF	OFF
	You can turn off or select another parameter as the loop display parameter of energy line 3.				

## Operation

20-Heat unit and time configuration					
20-0	Heat type	Option	Factory	Auto/heat/cold	Auto
	Users choose heat type.				
20-1	Heat unit	Option	Factory	kW, MW, kJ/h, MJ/h, GJ/h	GJ/h
	Heat unit and total unit synchronization, in normal use, please carefully modify the parameters.				
20-2	T Damping(s)	Option	Factory	0-99	2
	Temperature filter damping, set the time constant for smoothing the temperature display.				
20-3	4mA~20mA type	Option	Factory	Flow/Power	Flow
	Select flow / power as the 4mA~20mA output type, power output to kW as the unit.				
20-4	Power max.(kW)	Option	Factory	0.001-999999	1000.00
	Set power upper limit value. For frequency, output current limit threshold calculation. When the 4mA~20mA output type is selected as the power, this parameter is displayed.				
20-5	Pulse type	Option	Factory	Flow/Heat	Flow
	Select the Flow / Heat as the pulse output type, the heat output to kWh/Pulse as the unit. Need to first set the "3-0 Pulse output type" as the pulse equivalent output.				
20-6	kWh/Pulse	Option	Factory	0.001-999999	0.1
	Set the cumulative value of each pulse. Select the heat for the pulse output type, this parameter display.				
20-7	Date(YY/MM/DD)	Option	Factory		
	Set the instrument date, YY/MM/DD followed by year / month / day.				
20-8	Time(HH/MM/SS)	Option	Factory		
	Set the instrument time, HH/MM/SS in turn, time / minute / second.				



## Operation

21-Heat signal parameter					
21-0	Media	Option	Factory	Water/Other	Water
	Users choose to measure medium, water or other.				
21-1	Pressure	Option	Factory	0.6MPa/ 1.6MPa	0.6MPa
	Set water pressure value. Select water as the measuring medium, this parameter display.				
21-2	Heat C	Figure	Factory	1.00-100.00	4.20
	Set the specific heat capacity of the heat calculation of other media. When the measurement medium is selected as the other medium, this parameter is displayed.				
21-3	Density(kg/m <sup>3</sup> )	Figure	Factory	100-9999.99	1000.00
	Set the density value of the heat calculation of other media. When the measurement medium is selected as the other medium, this parameter is displayed.				
21-4	TD min(°C)	Figure	Factory	0.0-3.0	0.2
	When the temperature difference between Tin and Tout is smaller than the set of small temperature difference,default no heat generation.				
21-6	Tin adjust(°C)	Figure	Factory	-3.0-3.0	0.0
	Adjust the supply temperature setting.				
21-7	Tout adjust(°C)	Figure	Factory	-3.0-3.0	0.0
	Adjust the return temperature setting.				
21-8	Density type	Option	Factory	Tin、Tout	Tin
	Users choose the density calculation method.				

## Operation

---

### 6.6 Quick setup menu

1. Press on  $\triangleright$  and  $\triangleleft$  at same time ,Instrument parameter is set at the interface.Password need to be input at this time.  
**Quickly set the password : 300000**
2. The user can use the key  $\triangleright$  to switch between menu pages, use the key  $\triangle$  and key  $\nabla$  to adjust the parameter value, then use the key  $\triangleleft$  to confirm.
3. The parameters that can be set are shown in the table below.
4. After modification, move to the menu page [exit config], select Y and press on  $\triangleleft$ .

NO.	Parameter words	Setting mode	Parameter range	default
1	The sensor size	Option	3-2000	50
2	Flow range	Figure	0-99999	35.000
3	Sensor coefficient	Figure	0-99999	1.000
4	Zero correlation	Figure	0-99999	0.0
5	accumulation reset	Option	Y、N	N
6	Flow remove	Figure	0-99%	1%
7	time constant	Figure	0-99S	3s

## Chapter 7 Functions

### 7.1 System information

Flow meter itself has the self-diagnosis function, in addition to the power supply and circuit board hardware failures, it can correctly provide the corresponding alarm message to the fault in general application .

#### Display position in measuring picture

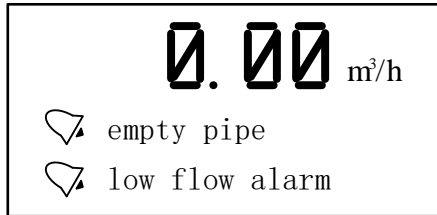

#### System information sheet

Display	Alarm content
empty pipe	Sensor empty pipe
high flow alarm	The current instantaneous flow rate exceeds the setting flow limit
low flow alarm	The current instantaneous flow rate is below the setting flow lower limit
overrun pulse limit alarm	The pulse output frequency exceeds the setting frequency upper limit
overrun flow limit	The current instantaneous flow rate exceeds the setting flow limit

# Functions

---

## 7.2 Accumulated report instructions

### Display Screen Switch

The user can use the  key to switch between the flow screen, the accumulated report screen, and the power-down record screen.

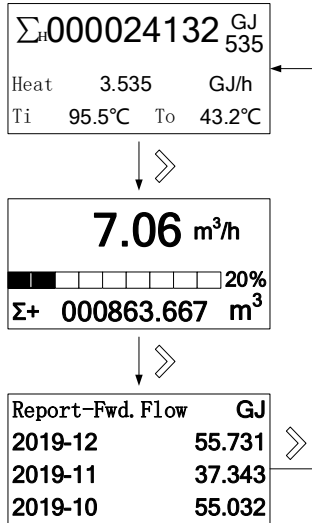

The cumulative report can record the latest 18 pieces of information in the last 18 months of four report types: Report -Fwd. Flow, Report -Rev. Flow, Report -Cold and Report -Heat.

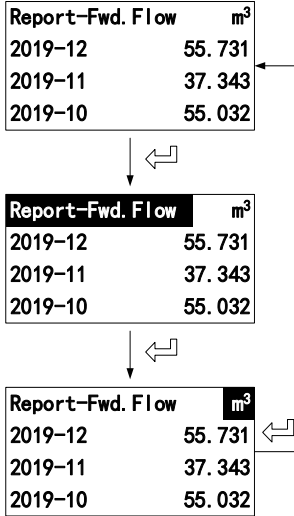

**Query cumulative reports**

Use the  key on the cumulative report screen to switch between report query status, report type switching status, and cumulative data unit switching status.



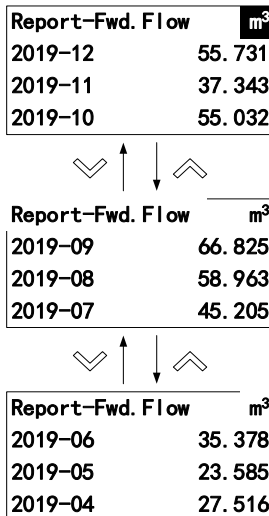

In the report query state, use  and  keys to switch the report list.



## Functions

---

In the report type switching state, use the  and  keys to switch the report data type: Report -Fwd. Flow, Report -Rev. Flow, Report -Cold and Report -Heat.

Report-Rev. Flow	m <sup>3</sup>
2019-12	0.108
2019-11	0.000
2019-10	0.000



Report-Fwd. Flow	m <sup>3</sup>
2019-12	55.731
2019-11	37.343
2019-10	55.032



Report-Cold	GJ
2019-12	40.031
2019-11	27.243
2019-10	33.132



Report-Heat	GJ
2019-12	105.031
2019-11	112.673
2019-10	155.332

In the accumulated data unit switching state, use the  $\triangle$  and  $\nabla$  keys to switch the accumulated data unit.

Flow unit: L, m<sup>3</sup>, kg, t, gal, lgal

Heat / Cold unit: kWh, MWh, kJ, MJ, GJ

Report-Fwd. Flow		<b>L</b>
2019-12	55753.015	
2019-11	37343.724	
2019-10	55032.856	



Report-Fwd. Flow		<b>m<sup>3</sup></b>
2019-12	55.731	
2019-11	37.343	
2019-10	55.032	

Report-Heat		<b>MJ</b>
2019-12	105031.222	
2019-11	112673.045	
2019-10	155332.333	



Report-Heat		<b>GJ</b>
2019-12	105.031	
2019-11	112.673	
2019-10	155.332	

### Cumulative report configuration

Menu 23-0, setting parameter Y can clearly accumulate reports.

Clear report	
	23-0
N	

## Functions

---

### 7.3 Pulse/Frequency/Current output

#### **Pulse equivalent output**

It is mainly used for sensor manufacturer coefficient calibration and user measurement use. In the third way configuration parameter Settings:

Pulse equivalent corresponding cumulants, indicate each pulse corresponding to the relevant volume number.

For example :

Parameter setting as 0.1L/p

The current instantaneous flow 3.6m<sup>3</sup>/h

Number of pulses per second output is :  $3.6 \times 1000 / 3600 / 0.1 = 10$

#### **Notes :**

When the parameter is set to 0.4L/p

The current instantaneous flow is 3.6m<sup>3</sup>/h

Number of pulses per second output is :  $3.6 \times 1000 / 3600 / 0.4 = 2.5$

Encounter the above situation, the decimal part of 2.5 pulse will automatically get into the next second output, data loss will not happen.

The pulse equivalent shouldn't be set too small when the pipe flow is small, otherwise it will cause pulse output exceeds the limit, then the main screen will appear [overrun pulse limit alarm] system alarm information. Users need to reset pulse equivalent parameters. Similarly, when the pipe flow is small the selected pulse equivalent cannot too big, otherwise it will cause the instrument to output a pulse for a long time, cause measurement error.

Pulse equivalent output is different from frequency output, pulse output will output a pulse when a pulse equivalent is accumulated enough, so the pulse output is uneven. Counter instrument should be used when measure pulse output, Frequency meter instrument shouldn't be used.

#### **Frequency output**

It is mainly used for manufacturer coefficient calibration and user measurement use. In the third group configuration parameters setting : frequency corresponding to instantaneous flow rate , upper frequency limit corresponding to max. flow rate .

**Note: the maximum frequency set to 5000 hz.**



**Current output**

Mainly used for transmitting output to other intelligent instruments, such as: digital display table, recorder, PLC, DCS, etc.

The current output type : 4-20mA.

The current valve corresponding to Instantaneous flow rate , 20 mA corresponding to range limit, 4 mA corresponding to range limit.

Conversion relationship

$$I_{\text{real time}} = \frac{Q_{\text{real time}}}{Q_{\text{max}}} 16.00 + 4.00$$

Unit : mA

Notice :

$Q_{\text{real time}}$  Indicate the instantaneous flow rate

$Q_{\text{MAX}}$  Indicate the current instrument range

$I_{\text{real time}}$  Indicate Real time current value

## Functions

### 7.4 Serial communication

This instrument provides a standard RS485 serial communication interface, using the international standard MODBUS-RTU communication protocol that supports 04 Read Input Registers command.

#### Register address

Parameter	Type	Address	Explanation
Real flow rate	float	100	
Real flow velocity	float	102	
Flow percentage	float	104	50 stands for 50%
Electric conductivity	float	106	
Forward flow accumulation of integer	ulong	108	
Forward flow accumulation of decimal	ulong	110	The decimal part magnifies 1000 times 123stand for 0.123
Reverse flow accumulation of integer	ulong	112	
Reverse flow accumulation of decimal	ulong	114	The decimal part magnifies 1000 times 123stand for 0.123
Real heat rate	float	120	
Water supply Temperature	float	122	
Return water temperature	float	124	
Heat accumulated integer	ulong	126	
Heat accumulated decimal	ulong	128	Decimal part magnification of 1000, 123 representatives 0.123
Cold accumulated integer	ulong	130	
Cold accumulated decimal	ulong	132	Decimal part magnification of 1000, 123 representatives 0.123
Heat unit	ushort	134	0x00: kW, 0x01: MW 0x02: kJ/h, 0x03: MJ/h 0x04: GJ/h
Cumulative heat unit	ushort	135	0x00: kWh, 0x01: MWh 0x02: kJ, 0x03: MJ, 0x04: GJ

Note: float/ulong/long type data, Communication transmission in byte order 2-1-4-3; ushort type data Transmission in accordance with 2-1.

**Communication configuration**

Mailing address : 1-247;

Default address : 8;

Baud rate : 1200, 2400, 4800, 9600, 19200, 38400, 57600;

The default baud rate : 9600;

Check: no check, odd parity, parity;

Default no check;

For 32-bit data (long plastic or floating point) arranged in the communication frame;

Example : Long integer 16909060(01020304H) : 03 04 01 02

Floating number 4.00(40800000H) : 00 00 40 80

**Readout real-time quantity floating-point communications, example:**

Real-time Floating-point Numbers readout

Send message : 08 04 00 63 00 02 81 4C

Return message : 08 04 04 22 6E 41 3F 79 61(Instantaneous flow rate : 11.95)

Forward flow rate accumulate readout

Send message : 08 04 00 6B 00 04 80 8C

Return message :08 04 08 00 6C 00 00 00 7B 00 00 D6 8E (The cumulative integer : 108 , Cumulative decimal : 0.123 , Accumulation : 108.123)

## Functions

---

### 7.5 Hart Communication

This instrument provides Hart 6.0 communication interface and supports the following communication commands.

#### **HART command 0: read identification code**

Returns the extended device type code, version and device identification code.

<b>Request</b>	
None	
<b>Response</b>	
Byte 0	254
Byte 1	Manufacturer ID
Byte 2	Device type
Byte 3	The minimum number of leading characters requested (master-> slave)
Byte 4	Common command document version number
Byte 5	Device specification version number
Byte 6	Device software version number
Byte 7	(First five bits) device hardware version number, (last three bits) physical signal type
Byte 8	Device mark
Byte 9-11	Device ID No.
Byte 12	Minimum number of preambles to respond (from-> master)
Byte 13	Maximum number of device variables
Byte 14-15	Configuration modification count
Byte 16	Additional equipment status (maintenance required/ parameter alarm)

**HART command 1: Read the pivot variable (PV).**

Returns the value of the pivot variable as a float type.

Request	
None	
Response	
Byte 0	Unit code for pivot variable
Byte 1-4	Value of pivot variable

**HART command 2: read the host variable current value and percentage**

Read the host variable current and percentage. The host variable current always matches the AO output current of the device. The percentage is not limited to 0-100%. If the range of the host variable is exceeded, the upper and lower limits of the sensor will be tracked.

Request	
None	
Response	
Byte 0-3	Host variable current, Unit milliamperes (mA)
Byte 4-7	Percentage of host variable range (%)

**HART command 3: read dynamic and host variable currents**

Read the host variable current and 4 (max) predefined dynamic variables. The host variable current always matches the AO output current of the device. Second, third, and fourth variables are defined for each device type. Such as the second variable is the sensor temperature.

Request	
None	
Response	
Byte 0-3	Host variable current, unit milliamperes (mA)
Byte 4	host variable unit code
Byte 5-8	host variable value
Byte 9	Second variable unit code
Byte 10-13	Second variable value
Byte 14	Third variable unit code
Byte 15-18	Third variable value
Byte 19	Forth variable unit code
Byte 20-23	Forth variable value

# Functions

## HART Command 6: Write Polling Address

This command writes Polling address to the device, which is used to control the output of the host variable AO and provide the device identification.

Only when the device's Polling address is set to 0, the device's host variable AO can be output. If the address is 1 ~ 15, AO is inactive and does not respond to the application process. At this time, AO is set to the minimum, and set the third bit of the transmission state-the analog output of the host variable is fixed; the upper / lower limit alarm is invalid. If the Polling address is changed back to 0, the host variable AO is active again and can respond to the application process.

The second byte returns whether the device is in current mode. The following commands can be used only when current mode is enabled:

- 40 #: Enter / exit fixed current mode
- 45 #: Adjust current zero point
- 46 #: Adjust the current gain
- 66 #, 67 #, 68 #: Analog output mode

Request	
Byte 0	Polling address of the device
Byte 1	Current mode code
Response	
Byte 0	Polling address of the device
Byte 1	Current mode code

## HART Command 14: Read Master Variable Sensor Information

Read host variable sensor serial number, the sensor upper / lower limit (span) unit code, the host variable sensor upper limit, the host variable sensor lower limit, and the minimum sensor accuracy. The unit of the sensor upper / lower limit / minimum accuracy (Span) is the same as the unit of the host variable.

Request	
None	
Response	
Byte 0-2	host variable sensor serial number
Byte 3	host variable sensor upper and lower limits and minimum precision unit code (Enum)
Byte 4-7	host variable sensor upper limit
Bytes 8-11	host variable sensor lower limit
Bytes 12-15	Minimum variable sensor accuracy

**HART Command 15: Read Device Information**

Read host variable alarm selection code, host variable transfer function code, host variable range unit code, host variable upper limit value, host variable lower limit value, host variable damping value, write protection code, and host publisher code.

The primary variable damping value is used for equipment range percentage and variable current.

Request	
None	
Response	
Byte 0	host variable alarm selection code (Enum) (useless)
Byte 1	Transfer function code (Enum) of host variable (useless)
Byte 2	Unit code of the upper and lower range value of the host variable (Enum)
Bytes 3-6	host variable upper limit
Bytes 7-10	Lower limit of the host variable
Bytes 11-14	host variable damping value, unit is second
Byte 15	Write Protected Code (Enum) (useless)
Byte 16	Private Label Distributor Code (Enum) (useless)
Byte 17	host variable analog channel flag, whether it is a field device analog input channel (useless)
Bytes 18-20	Date (useless)

**Command 34: Write the host variable damping value**

This is a command about host variables.

The host variable damping value represents a time constant (by that time, the output to the step response should be 63% of the steady state value). Both the analog and digital outputs of the variable use this variable.

Request	
Byte 0-3	Damping value of host variable, unit is second
Response	
Bytes 0-3	Actual primary variable damping value, unit is second

# Functions

---

## Command 35: Write host variable range value

This is a command about the range of the host variable.

The upper limit and lower limit of the host variable range are independent. Most devices allow the upper limit of the range of the device to be lower than the lower limit, so that the device works in reverse output.

The host variable unit received by this command does not affect the host variable unit of the device. The host variable range value is returned in the receiving unit.

Request	
Byte 0	host variable range unit code
Bytes 1-4	Upper limit of host variable range
Byte 5-8	Lower limit of host variable range
Response	
Byte 0	host variable range unit code
Bytes 1-4	Upper limit of host variable range
Bytes 5-8	Lower limit of host variable range

## Command 40: Enter / exit fixed host variable current mode

This is a command about loop current.

The device is configured as a fixed host variable current mode, and the response value shows the actual current value of the current device.

If the request value is set to "0", it will exit the fixed current mode, and it also will exit when the device is powered off.

Request	
Byte 0-3	Fixed main variable current value, unit is milliamperere
Response	
Byte 0-3	Actual fixed main variable current value, unit is milliamperere

## Command 44: Write host variable units

This is a command about host variables.

Select a host variable unit. Both the host variable value and the range are returned in that unit. The host variable sensor upper and lower limits and the minimum precision Span of the host variable also use this value as a unit.

Request	
Byte 0	host variable unit code (Enum)
Response	
Byte 0	host variable unit code (Enum)



**Command 45: adjust loop current zero**

This is a command about loop current.

Adjust the loop current value to 0 or the lower limit value, usually set the loop current to 4.00mA. The current value sent may be rounded or truncated, and the current value will be returned.

If the device does not enter the correct loop current mode or the current is not set to the exact minimum value, need to return response code 9 --- incorrect current mode or value.

Request	
Byte 0-3	External measured current value, unit is milliampere
Response	
Byte 0-3	Actual measured host variable current value, unit is milliampere

**Command 46: Adjust loop current gain**

This is a command about loop current.

Adjust the loop current value to the maximum, usually set the loop current to 20.00mA. The current value sent may be rounded or truncated, it will return to the present current value.

If the device does not enter the correct loop current mode or the current is not set to the exact minimum value, need to return response code 9 --- incorrect current mode or value.

Request	
Byte 0-3	Externally measured host variable value, unit milliampere
Response	
Byte 0-3	Actual measured main variable current value

**Command 59: Write the number of response leaders**

This is a data link layer management command and is only applied to asynchronous physical layer links, such as FSK.

This command selects the minimum number of preambles to send before the response packet starts. This number includes the two leading characters contained in the message header. The number may be set to 5-20.

Request	
Byte 0	number of preambles to send in response message
Response	
Byte 0	number of preambles to send in response message

## Functions

---

### **Example: adjusting the loop current zero**

The 4-20mA loop transmits a dynamic master variable through an analog signal, which requires that the loop current value between the master and the slave must be uniform. The loop current command allows the host to impose a loop current value on the field device and perform two-point adjustment of the field device loop current value (corresponding to zero and span). The loop current adjustment process is as follows:

1. Enter / exit the fixed current mode through command No. 40, and set the current to the minimum value of the device, usually 4mA;
2. Through command 45, adjust the zero point of the loop current. After the device is adjusted, it returns the current value, which may be different from the host setting due to rounding;
3. Enter / exit the fixed current mode by command No. 40, and set the current to the maximum value of the device, usually 20mA;
4. Through command 46, adjust the loop current gain.
5. If you need to be more precise, repeat steps 1-4. After the loop current is calibrated, exit the fixed current mode (set 0mA) through command 40.

## 7.6 Bluetooth communication

This instrument is bluetooth 4.0 communication.

### Install the software

Emble.apk should be installed on the phone

### Bluetooth connection

When bluetooth is connected, the mobile phone will first turn on the Bluetooth function, then open the installed EMBle software, and click "Search" to conduct bluetooth search.

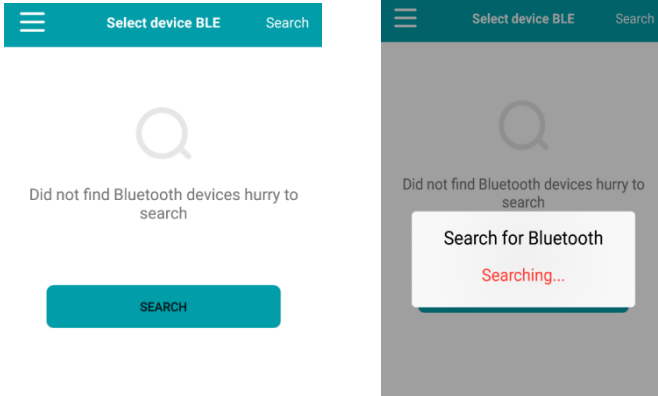

After searching for the instrument matching bluetooth address, select confirm for

### Bluetooth connection

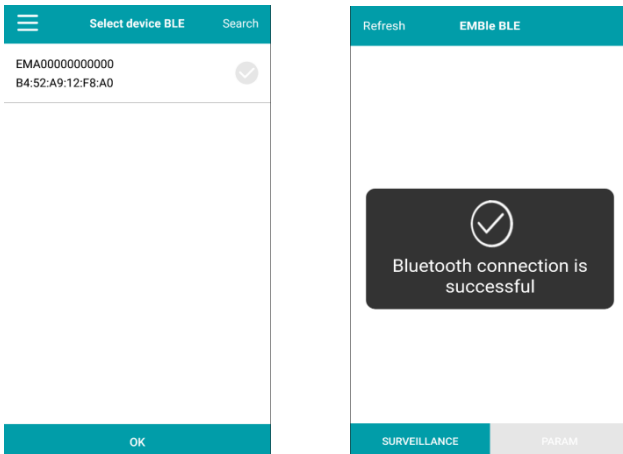

## Functions

After the Bluetooth connection is successful, the parameters can be monitored and modified

Refresh	EMBLE BLE
Heat	296.002GJ/h
Tin	60.00°C
Tout	40.00°C
TD	20.00K
Flow	7.069m3/h
Alarm	No alarm
Sys	No alarm
Mtsnsr	Have alarm
Hi	No alarm
Lo	No alarm

**SURVEILLANCE**      PARAM

Refresh	EMBLE BLE	Data Output
Language		Chinese
Heat range		10.0
Heat unit		GJ/h
Work mode		Auto
T Damping(s)		2
TD min(°C)		1.0°C
Flow range		35.0
Flow unit		m3
Time unit		h
Display accuracy		2

SURVEILLANCE      **PARAM**

---

## 7.7 Firmware upgrade instructions

1. Connect the instrument and computer through RS485 serial communication interface, open [DFU firmware online upgrade] software, and click [next].
2. Enter the [1/5 open upgrade package] interface, click the folder and select the given upgrade package file. The file name is: current version → upgrade version, and the format is [. dfu], such as [Q53H3006 → Q53H3010. dfu], then click [next]
3. Enter the [2/5 communication configuration] interface and select [serial port], [communication address], [baud rate], [verification method] (It is consistent with the parameters set in the instrument).
4. Enter the [3/5 connect instrument] interface, confirm that the [instrument string code] is the firmware version of the current instrument, and click [next].
5. Enter the [4/5 upgrade warning] interface and enter the [upgrade authorization code] provided by the manufacturer. To upgrade the 485 communication firmware online, you should first adjust the instrument screen to [11-2 Source code], select [Y], and then click [next] of DFU software.
6. Enter the [5/5 download firmware] interface, wait for the firmware upgrade to display [finish], and click [finish]. Enter the instrument configuration interface and confirm the firmware version in the upper right corner.

## Functions

---

### 7.8 Operation instructions of flow correction function

In principle, used for small flow rate less than (0.5 m/s) linear adjustment. Correction calculation is conducted on the original sensor flow coefficient curve correction, therefore, should be closed nonlinear correction function, mark sensor coefficient. Then allow the nonlinear correction function, according to the nonlinear of sensor, setting correction coefficient, piecewise corrected. If the coefficient is set right, no need to calibration.

The functional design with 4 period of correction, is divided into four flow point and correction coefficient.

#### **The corresponding velocity of correction point must meet:**

Correction point 1  $\geq$  Correction point 2  $\geq$  Correction point 3  $\geq$  Correction point 4  $\geq$  0.

**The original velocity stand for the real standard velocity, the revised flow velocity is called modified velocity, the modified computation formula is as follows:**

- The original flow velocity  $\geq$  The modified point 1  
The flow velocity keep unchangeable.
- At the interval of the modified point 1  $>$  The original flow velocity  $\geq$  The modified point 2  
The modified flow velocity = Correction factor 1  $\times$  The original flow velocity
- At the interval of the modified point 2  $>$  The original flow velocity  $\geq$  The modified point 3  
The modified flow velocity = Correction factor 2  $\times$  The original flow velocity
- At the interval of the modified point 3  $>$  The original flow velocity  $\geq$  The modified point 4  
The modified flow velocity = Correction factor 3  $\times$  The original flow velocity
- At the interval of the modified point 4  $>$  The original flow velocity  $\geq$  0  
The modified flow velocity = Correction factor 4  $\times$  The original flow velocity

Note: when set the modified point, should keep the following relationship Modified point 1  $>$  Modified point 2  $>$  Modified point 3  $>$  Modified point 4  $>$  0. The intermediate value of Correction coefficient is 1.0000, if the correction coefficient is greater than 1, then increase the flow velocity; if the correction coefficient is less than 1, then decrease the flow velocity.

**Case1:**

The original flow velocity:0~0.4m/s, correction factor changes to 1.2.

**Parameter setting**

Flow correction point 1	Flow correction point 2	Flow correction point 3	Flow correction point 4
0.4	0	0	0
Flow correction coefficient 1	Flow correction coefficient 2	Flow correction coefficient 3	Flow correction coefficient 4
1.2	1	1	1

**The modified flow velocity**

The original flow velocity	The modified flow velocity
0~0.4m/s	1.2 × The original flow velocity

**Case2:**

The original flow velocity:0.2~0.4m/s, correction factor changes to 0.9.

The original flow velocity:0.4~0.5m/s, correction factor changes to 1.1.

**Parameter setting**

Flow correction point 1	Flow correction point 2	Flow correction point 3	Flow correction point 4
0.5	0.4	0.2	0
Flow correction coefficient 1	Flow correction coefficient 2	Flow correction coefficient 3	Flow correction coefficient 4
0.9	1.1	1	1

**The modified flow velocity**

The original flow velocity	The modified flow velocity
0.2~0.4m/s	0.9 × The original flow velocity
0.4~0.5m/s	1.1 × The original flow velocity

## Functions

---

### Case3:

The original flow velocity:0.1~0.2m/s, correction factor changes to 0.9.

The original flow velocity:0.2~0.3m/s, correction factor changes to 1.1.

The original flow velocity:0.3~0.4m/s, correction factor changes to 0.8.

### Parameter setting

Flow correction point 1	Flow correction point 2	Flow correction point 3	Flow correction point 4
0.4	0.3	0.2	0.1
Flow correction coefficient 1	Flow correction coefficient 2	Flow correction coefficient 3	Flow correction coefficient 4
0.8	1.1	0.9	1

### The modified flow velocity

The original flow velocity	The modified flow velocity
0.1~0.2m/s	$0.9 \times$ The original flow velocity
0.2~0.3m/s	$1.1 \times$ The original flow velocity
0.3~0.4m/s	$0.8 \times$ The original flow velocity

### Case4:

The original flow velocity:0.1~0.2m/s, correction factor changes to 0.9.

The original flow velocity:0.3~0.4m/s, correction factor changes to 1.1.

### Parameter setting

Flow correction point 1	Flow correction point 2	Flow correction point 3	Flow correction point 4
0.4	0.3	0.2	0.1
Flow correction coefficient 1	Flow correction coefficient 2	Flow correction coefficient 3	Flow correction coefficient 4
1.1	1	0.9	1

### The modified flow velocity

The original flow velocity	The modified flow velocity
0.1~0.2m/s	$0.9 \times$ The original flow velocity
0.3~0.4m/s	$1.1 \times$ The original flow velocity



**Case5:**

The original flow velocity:0~0.2m/s, correction factor changes to 0.9.

The original flow velocity:0.2~0.3m/s, correction factor changes to 1.1.

The original flow velocity:0.3~0.4m/s, correction factor changes to 0.8.

The original flow velocity:0.4~0.5m/s, correction factor changes to 0.9.

**Parameter setting**

Flow correction point 1	Flow correction point 2	Flow correction point 3	Flow correction point 4
0.5	0.4	0.3	0.2
Flow correction coefficient 1	Flow correction coefficient 2	Flow correction coefficient 3	Flow correction coefficient 4
0.9	0.8	1.1	0.7

**The modified flow velocity**

The original flow velocity	The modified flow velocity
0~0.2m/s	$0.7 \times$ The original flow velocity
0.2~0.3m/s	$1.1 \times$ The original flow velocity
0.3~0.4m/s	$0.8 \times$ The original flow velocity
0.4~0.5m/s	$0.9 \times$ The original flow velocity

## Technical parameters

### Chapter 8 Technical parameters

#### 8.1 Technical parameters

##### Measuring system

Measuring principle	Faraday's law of electromagnetic induction	
Function	Instantaneous flow rate, flow velocity, mass flow (when the density is constant), real-time measurement and flow accumulation	
Module configuration	Measurement system is made up of signal converter and measurement sensor.	
<b>Flow meter</b>		
Protection class	IP65 or IP68	
<b>Pipeline sensor</b>		
Nominal Diameter	DN15-DN2000	
Flange	In line with GB / T9119-2000 standard carbon steel (Optional stainless-steel flanges), another standard flange can be customized	
Pressure rating (High pressure can be customized)	DN15 - DN50, PN<4.0MPa	
	DN65 - DN150, PN<1.6MPa	
	DN200 – DN600, PN<1.0MPa	
	DN700 – DN2000, PN<0.6MPa	
Lining Material	Chloroprene rubber (CR), Silicon fluorine rubber (FVMQ) Polytetrafluoroethylene (PTFE/F4), Fluorinated ethylene propylene (FEP/F46), Teflon (PFA)	
Electrode Material	316L Stainless Steel, Hastelloy C, Hastelloy B, Ti, Ta, Pt	
Medium temperature	-20 – 180℃	-20 – 80℃
Buried depth	Less than 5 meters (only IP68 protection of split type sensor)	
Immersion depth	Less than 3 meters (only IP68 protection of split type sensor)	

**Function**

Communications	Serial, Hart, Bluetooth
Output	Current (4-20 ma), Pulse, frequency, State switch
Function	ATC recognition, electrode contamination

**Display user interface**

Graphic display	Monochrome LCD, white backlight, 128*64 pixels
	OLED, green, 128*64 pixels
Display function	measurement value pictures can automatic circulation (measurements, condition, etc.)
Language	English, Chinese
Unit	You can configure the menu to select the unit, see "6.3 Configuration details" and "flow units 1-1" and "4-0 Accumulation Unit" section.
Operating unit	Mechanical key

**Measurement accuracy**

Accuracy grade	Pipe segment type: 0.5%
Repeatability	Pipe segment type: 0.15%
Temperature sensor measurement range	-20°C~120°C
Max measuring error	± 0.1 °C (within the measuring range of the temperature sensor)
Repetitiveness	< 0.15%
Maximum measured flow rate	±12m/s

**Operating environment**

<b>Temperature</b>	
Environment	-10°C - 55°C
Storage	-40°C - 65°C
<b>Conductivity</b>	
Conductivity	> 30µS/cm

**Material**

Sensor housing	Carbon steel / Stainless steel
Converter	Standard die cast aluminum

## Technical parameters

### Electrical connections

Power supply	100-240VAC, 50/60Hz
Power consumption	Max 15VA
Shielded cable	Signal section, wire: 0.5mm <sup>2</sup> Cu /AWG20

### Output

Current output		
function	Measurement of volume and quality (in the case of constant density)	
Setting	scope	4-20mA
	Max	20mA
	Min	4mA
Internal voltage	24VDC	
loading	≤750Ω	
Pulse and frequency output		
function	Set up Pulse and frequency output	
Pulse output	basis	Output pulse width: 0.25ms ~100ms Duty cycle: 50% (Pulse frequency ≥5Hz) $F_{max} \leq 5000$ cp/s
	setting	0.001L – 1m <sup>3</sup>
frequency	Max	$F_{max} \leq 5000$ Hz
	setting	0-5000Hz
active	Active frequency/pulse output voltage $U_{inner} \leq 24$ VDC	
	Active frequency/pulse output current $I \leq 4.52$ mA	
passive	Outer ≤ 36VDC	
Status output		
function	Output as alarm	
passive	Outer ≤ 36VDC	
active	Active output voltage $U_{inner} \leq 24$ VDC	
	Active output current $I \leq 4.52$ mA	

8.2 Flow Meter

V[m/s]	Q <sub>100%</sub> Unit m <sup>3</sup> /h			
	0.3	1	3	7
DN[mm]	Min flow	Common flow		Max flow
2.5	0.01	0.02	0.05	0.14
4	0.01	0.05	0.14	0.35
6	0.03	0.10	0.31	0.70
10	0.08	0.28	0.85	1.96
20	0.34	1.13	3.39	7.91
25	0.53	1.77	5.30	12.39
32	0.87	2.90	8.69	20.27
40	1.36	4.52	13.57	31.67
50	2.12	7.07	21.21	49.48
65	3.58	11.95	35.84	83.62
80	5.43	18.10	54.29	126.67
100	8.48	28.27	84.82	197.92
125	13.25	44.18	132.54	309.25
150	19.09	63.62	190.85	445.32
200	33.93	113.10	339.30	791.70
250	53.01	176.71	530.13	1236.97
300	76.34	254.47	763.41	1781.29
350	103.91	346.36	1039.08	2424.52
400	135.72	452.39	1357.17	3166.73
500	212.06	706.86	2120.58	4948.02
600	305.37	1017.90	3053.70	7125.30
700	415.62	1385.40	4156.20	9697.80
800	542.88	1809.60	5428.80	12667.20
900	687.06	2290.20	6870.60	16031.40
1000	848.22	2827.40	8482.20	19791.80





---

---